



Micro Energy Storage System (Micro ESS)

SUN-BK80-2.56KWH-AA-AM4-18L

SUN-BK160-2.56KWH-AA-AM4-18L

SUN-BK200-2.56KWH-AA-AM4-18L

SUN-BK250-2.56KWH-AA-AM4-18L

SUN-BK80-2.56KWH-AA-AM4-32L

SUN-BK160-2.56KWH-AA-AM4-32L

SUN-BK200-2.56KWH-AA-AM4-32L

SUN-BK250-2.56KWH-AA-AM4-32L

User Manual















Contents

1. Safety Precautions	- 01 -
1.1 Meaning of Symbols.....	- 01 -
1.2 Safety Instruction	- 02 -
1.3 Precautions Before Connection	- 02 -
1.4 Precautions Before Use.....	- 02 -
2. Product Introduction	- 03 -
2.1 LED Display.....	- 03 -
2.2 Overview.....	- 04 -
3. Product Installation	- 04 -
3.1 Unboxing	- 04 -
3.2 Installation Steps	- 06 -
4. Electrical Connections	- 10 -
4.1 System diagram.....	- 10 -
4.2 PV Connection.....	- 11 -
4.3 Grid Connection.....	- 12 -
4.4 Load connection.....	- 14 -
4.5 Parallel Connection (Optional)	- 15 -
4.6 Backup Socket	- 20 -
4.7 Earthing Connection	- 20 -
4.8 CT Connection (Optional)	- 21 -
4.9 RS485 Connection (Optional)	- 23 -
5. System Configuration	- 24 -
5.1 Power On	- 24 -
5.2 Download the App.....	- 24 -
5.3 Register an Account	- 25 -
5.4 Create the Plant.....	- 27 -
5.5 Network Configuration.....	- 28 -
5.6 Setup Smart Devices.....	- 29 -
5.7 Setup Work Mode	- 31 -
5.8 AC Couple Setting	- 32 -
6. Deye Cloud Operating Instructions	- 35 -
6.1 Battery Setting	- 35 -
6.2 Storage Inverter Work Mode-1.....	- 36 -
6.3 Inverter System Settings	- 38 -
6.4 Storage Inverter Work Mode-2.....	- 38 -
6.5 Function Set	- 39 -
6.6 Smart Load Setting	- 40 -
7. Expansion Batteries	- 41 -
7.1 Technical Data	- 41 -
7.2 Installation	- 41 -

8. Applications	- 42 -
8.1 On Grid	- 42 -
8.2 Off Grid	- 42 -
9. FAQs and Troubleshooting	- 43 -
9.1 FAQs	- 43 -
9.2 Troubleshooting for Inverter Module	- 43 -
9.3 Troubleshooting for Battery Module	- 47 -
10. Appendix	- 52 -
10.1 After-sales Service	- 52 -
10.2 Disposal Instructions	- 52 -
10.3 EU Declaration of Conformity	- 53 -
10.4 Technical Data	- 56 -

1. Safety Precautions

1.1 Meaning of Symbols

Label	Description
	Caution Risk of electric shock. Please follow all safety instructions. Incorrect handling may cause electric shock.
	Do not ground the DC input terminals of the inverter.
	High Surface Temperature Do not touch the inverter case during or after operation.
	Disconnect AC and DC circuits separately. After disconnection, wait at least 5 minutes until all internal power is fully discharged before maintenance.
	CE Mark Attached to verify that the equipment complies with the requirements of the EU safety standards.
	Please read the instructions carefully before use.
	Treatment A compliance with European Directive 2002/96/EC on Waste Electrical and Electronic Equipment. Indicate that the device, accessories, and packaging must not be disposed of as unsorted municipal waste and require separate collection at end-of-life. Please comply with local disposal regulations or consult the manufacturer's authorized distributor for equipment decommissioning guidance.
	No Running or Chasing near the device.
	Keep Away from Open Flames or heat sources such as heaters.
	Do Not Touch with Bare Hands. Use appropriate tools or protection.
	Do Not Step On the Device.
	Recyclable Product This product is recyclable.
	Li-ion Battery Inside.
	Caution Risk of explosion. Handle batteries with care.

1.2 Safety Instructions

This chapter contains important safety and operation guidelines. Please read carefully and keep this manual for future reference.

- ① Read all the instructions and warning labels, as well as related chapters in this manual before using.
- ② Do not disassemble the equipment. For repair or maintenance, please contact a professional service center.
- ③ Improper reassembly may lead to electric shock or fire.
- ④ To reduce the risk of electric shock, disconnect all wires before performing maintenance or cleaning. Simply turning off the unit is not enough to reduce the risks.
- ⑤ Caution: Only qualified personnel are allowed to install this equipment.
- ⑥ Do not charge a frozen battery.
- ⑦ To ensure proper operation, select the correct cable size as required in the specifications.
- ⑧ Be extra careful when using metal tools near the battery. Dropping tools may cause sparks, short circuits, or even explosions.
- ⑨ Always follow the correct AC and DC disconnection procedures. Read this manual for detailed steps.
- ⑩ Grounding Requirement: The equipment must be connected to a permanent grounded wiring system. Installation must comply with local electrical codes and regulations.
- ⑪ Never allow a short circuit between the AC output and DC input.
- ⑫ Do not connect the equipment to the mains power supply (grid) if the DC input is short-circuited.

1.3 Precautions Before Connection

- ① After unpacking, please check the micro ESS and the packing list. If the micro ESS is damaged or any parts are missing, please contact the local retailer.
- ② Before installation, make sure the grid power is turned off and the micro ESS is switched off.
- ③ All connections must be correct. Do not allow any short circuit with external devices.
- ④ Keep the micro ESS away from any ignition sources.
- ⑤ Do not use parts or accessories that are not provided by the official supplier.
- ⑥ Do not place any objects on top of the micro ESS.

1.4 Precautions Before Use

- ① Before moving or repairing the micro ESS, disconnect the grid power and make sure the micro ESS is fully turned off.
- ② Do not connect this micro ESS with other batteries of different models.
- ③ Do not remove or disassemble any part of the micro ESS.
- ④ In case of fire, only use liquid fire extinguishers. Dry powder extinguishers are not allowed.
- ⑤ If the enclosure is tested without internal equipment, the enclosure manufacturer must specify detailed requirements for the arrangement and spacing of hazardous parts or parts that may be affected by foreign object or water ingress. The final product manufacturer must ensure that after installation, the enclosure meets the declared protection level.
- ⑥ Only operate the micro ESS on a stable and dry surface.

2. Product Introduction

The Deye 2500W/2560Wh Micro Energy Storage System (Micro ESS) has a built-in LiFePO₄ battery and supports AC charging/discharging, off-grid power supply (UPS), PV power charging up to 2500W, and battery expansion up to 12.8kWh. Users can monitor power status in real time via the touchscreen or app.

Specification of wireless module:

Wi-Fi module maximum transmitting power: 802.11b:+17±1.5dBm(@11Mbps);

802.11g:+15±1.5dBm(@54Mbps); 802.11n:+14±1.5dBm(@HT20,MCS7)

Frequency range: 2.412GHz-2.472GHz

Antenna: PCB Antenna

Antenna Gain: 1dBi

LoRa module maximum transmitting power: 9.34dBm

Frequency range: 863MHz-870MHz

Antenna: FPC Antenna

Antenna Gain: 0.07dBi

Please be kindly noted that specifications are subject to change without notice. Be sure to download the latest version of the manual from the manufacturer's official website www.deyeinverter.com.

2.1 LED Display

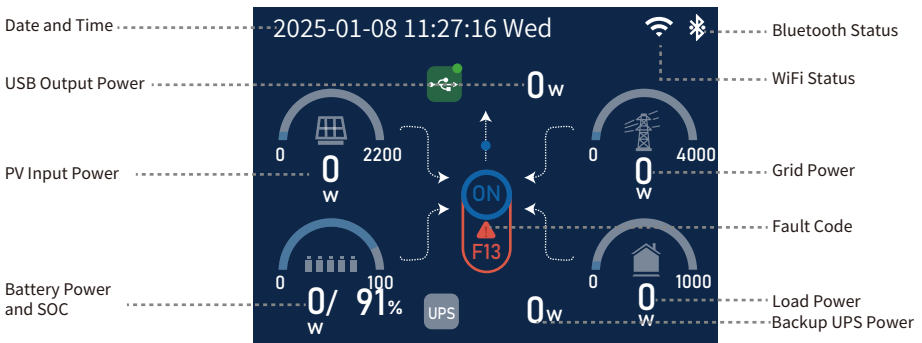

2.2 Overview

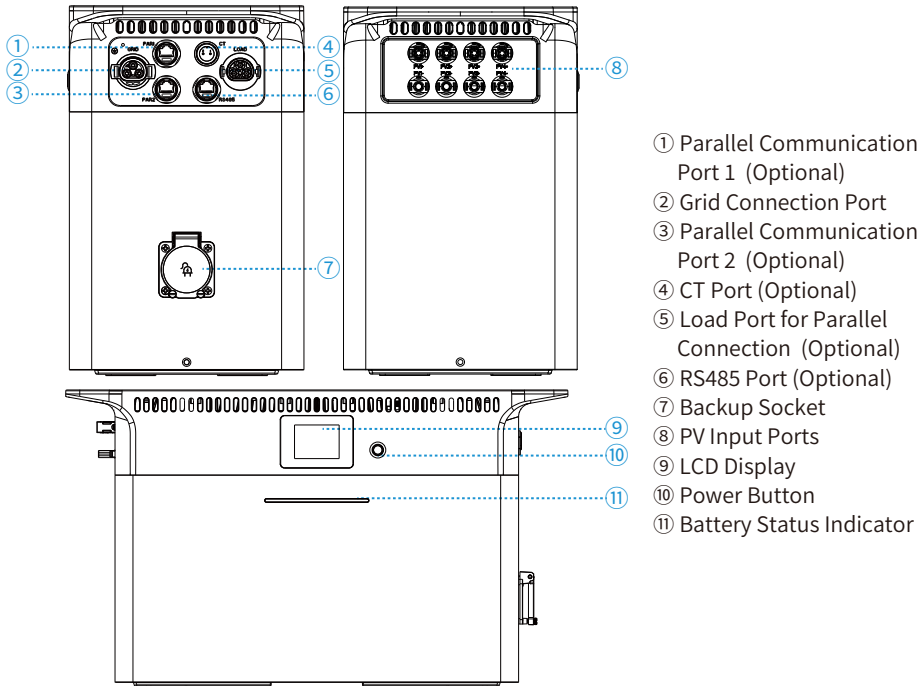

3. Product Installation

WARNING:





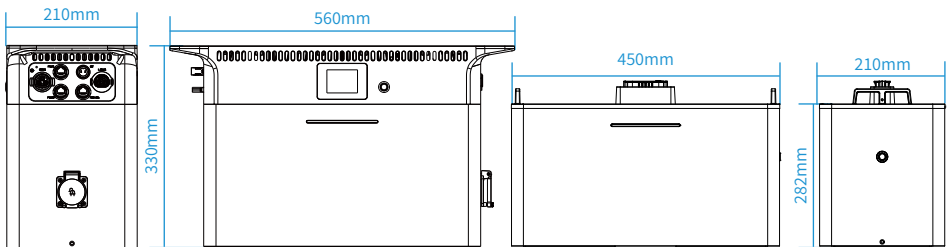



- * Keep the micro ESS away from direct sunlight, heat/fire sources, water submersion, strong vibration, noise, and electromagnetic interference to prevent damage or fire.
- * The micro ESS must be installed in a well-ventilated area with sufficient clearance. Do not place any objects on top of it.
- * Ensure the micro ESS is powered off during installation.

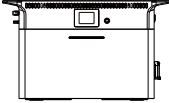
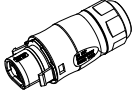
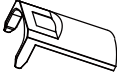
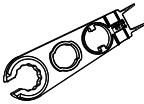

3.1 Unboxing

Refer to the following table and check if all necessary items are included in the package:

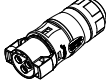
Picture	Standard Accessory	Quantity
	Micro ESS	1
	Grid Port Connector (Male)	1
	Disconnect Tool for Grid/Load Port Connector	1
	Disconnect Tool for PV Connector	1
	User Manual	1

Picture	Optional Accessory	Quantity
	CT (Current Transformer) with 5m of Lead Wire	1
	Parallel Communication Cable	1
	Load Port Connector (Female)	1
	8-Pin RS485 Communication Connector (Female)	1
	Smart Meter	1

3.2 Installation Steps

① Select proper installation site.

* Please ensure a minimum distance of 10mm from the wall at the back. A clearance of at least 300 mm must be maintained at the front, left, right, and top sides to allow proper ventilation and visibility of the LCD Screen.

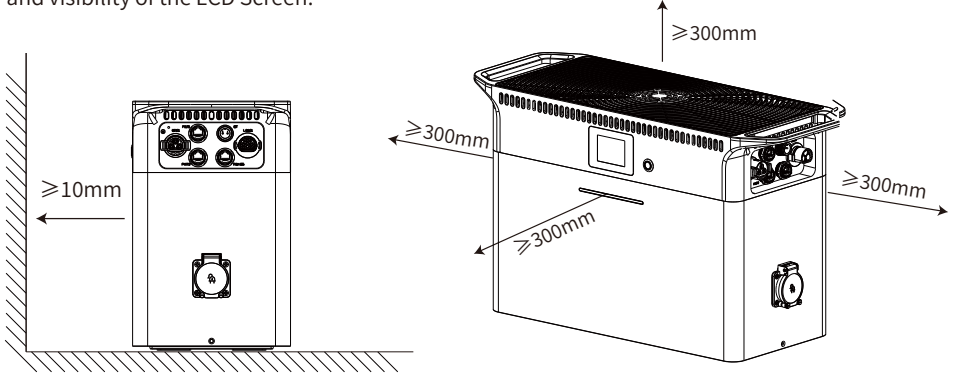

② Install DC parallel base (if any).

* Prepare the required tools.



* Cut off the side knockout slot with a diagonal cutter. Arrange the wiring harness and secure it in the groove to keep it fixed and prevent it from being pressed during stacking. Refer to the instructions below:

A. For stacking of 2 or 3 micro ESS units, cut position 1.

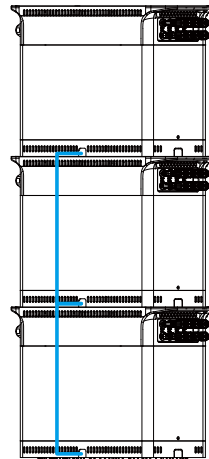
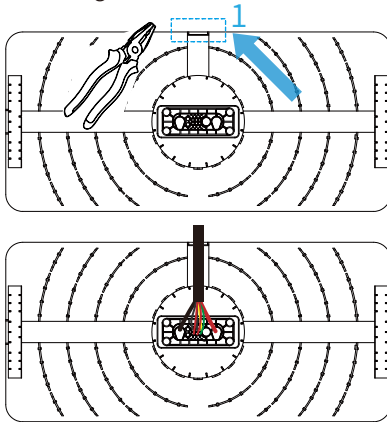

B. For micro ESS + expansion batteries as one unit, cut positions 2 and/or 3.

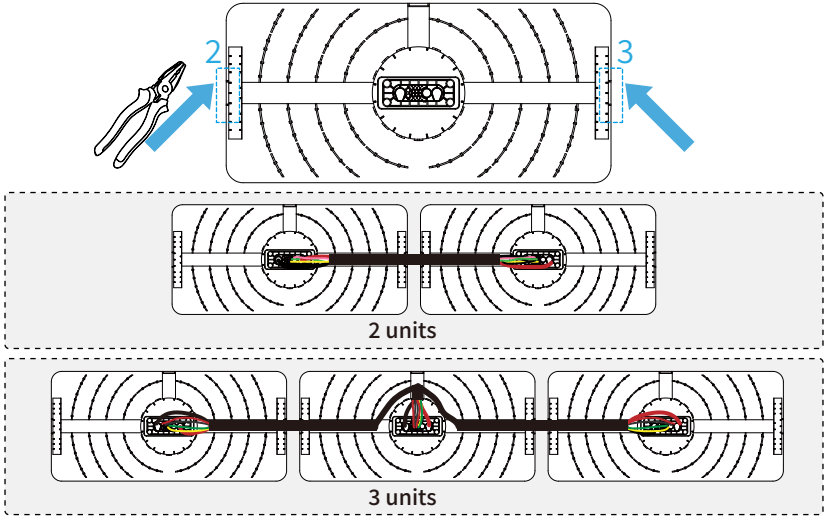

③ Install micro ESS / expansion batteries (if any).

* Use disconnect tool for PV to unlock the protective cover and remove it.

* Stack up to 4 expansion batteries and 1 DC parallel base in order, with the micro ESS on top. Align and connect the corresponding ports.

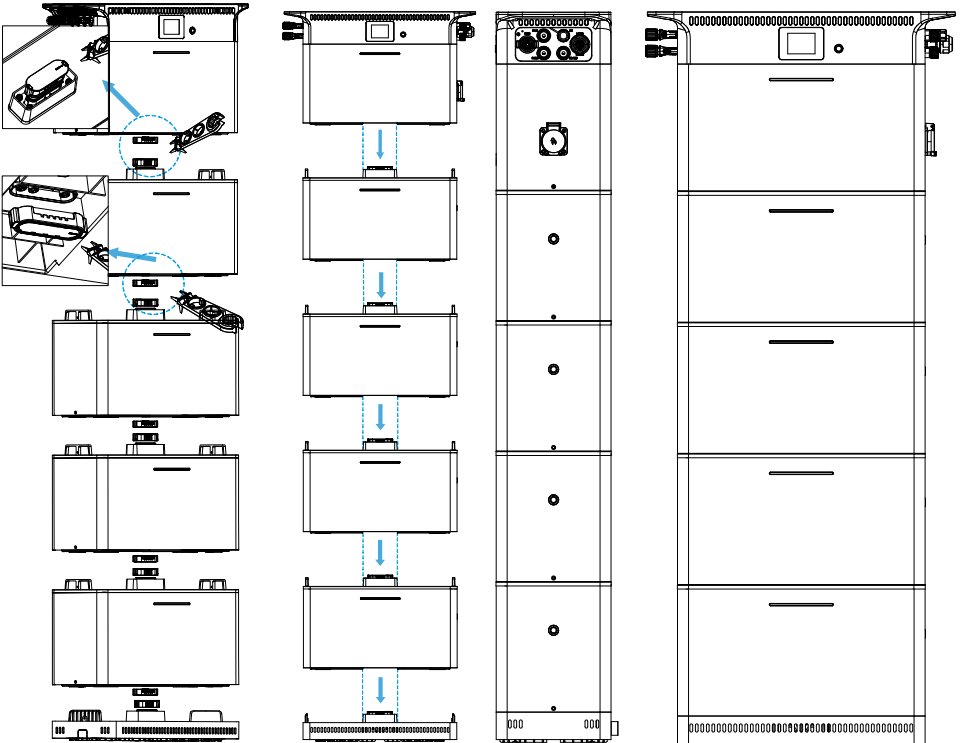



WARNING:

* If an expansion battery or DC parallel base is removed, insert the waterproof cap directly into the exposed stacking ports. Do not leave the stacking ports open to air, as this may cause electric shock, moisture ingress, or other hazards.

④ Install the wall mount kit (if any).

* Prepare the required tools.

Wall Mount Kit ((Standard Accessory in 1 Expansion Battery Package)

Required Tools

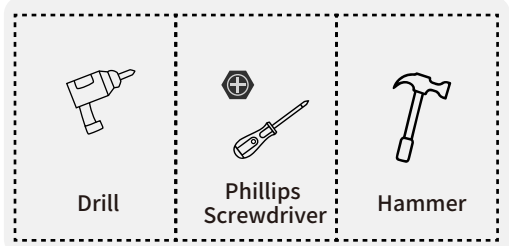
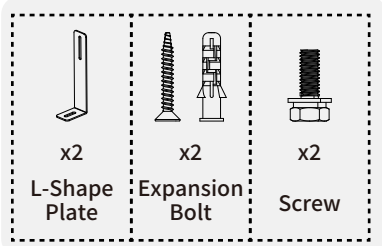

* Attach the L-shaped metal plates to both sides of the micro ESS. On one side, secure the L-shaped plate with a screw and partially tighten it.

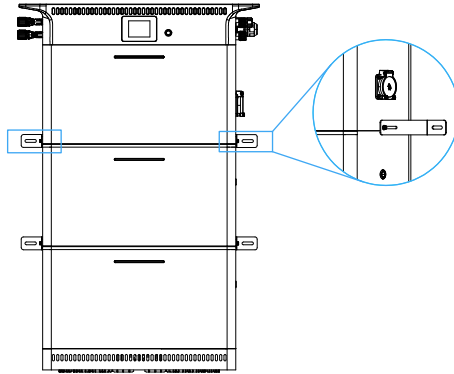

* Mark and drill a pilot hole and insert the anchor.

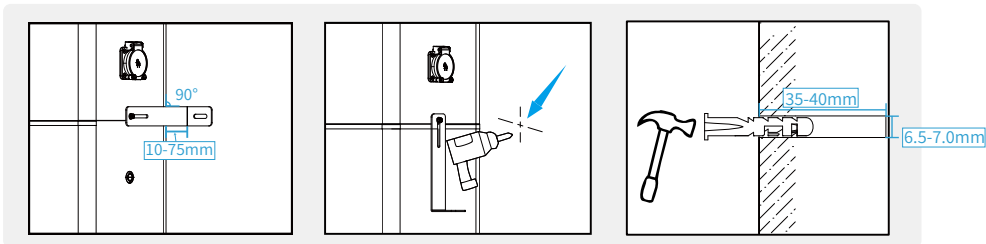

* Fully tighten the expansion bolt and the screw with a Phillips screwdriver.

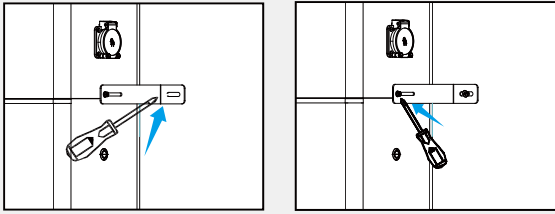

* Repeat the above steps to complete the installation of the wall mount kit for both the micro ESS and the expansion battery packs.

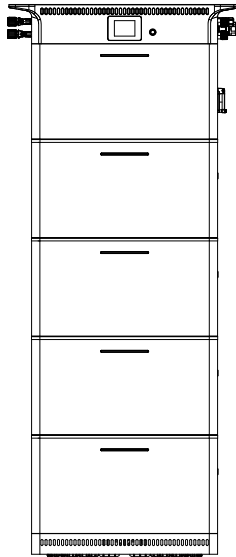

4. Electrical Connections



WARNING:

- * Ensure the device is powered off before making electrical connections.
- * Secure all connections properly to avoid electrical faults or device malfunctions.

4.1 System Diagram

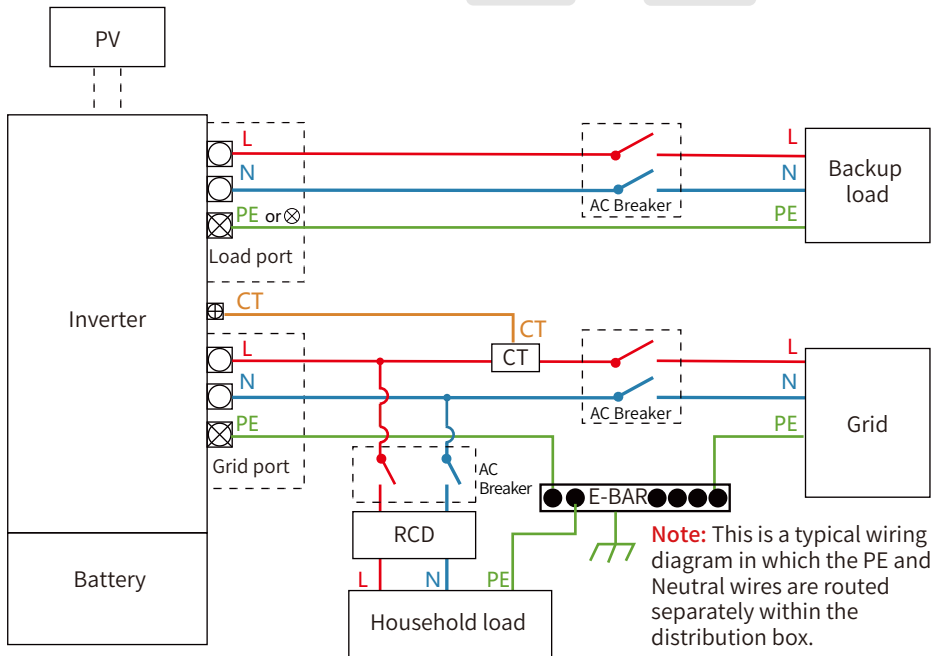
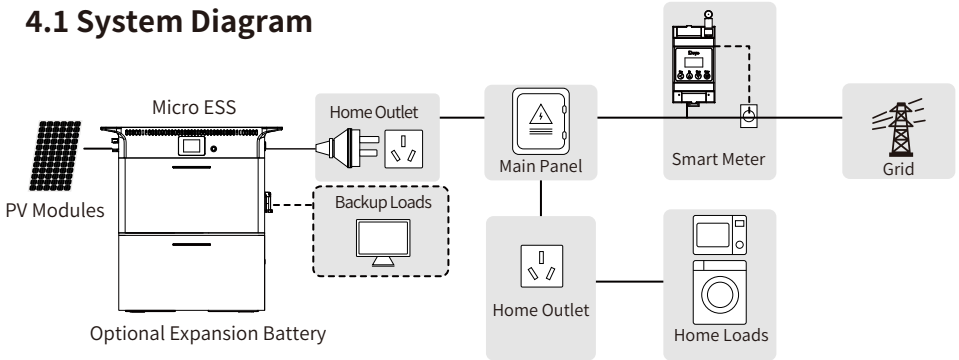

WARNING:

- A Type 2 SPD must be installed on the grid side of the ESS. If no SPD is installed, the ESS is limited to the following operating modes:
1. Off-grid mode.
 2. On-grid mode without backup loads. In this case, grid power can only be used for battery charging and cannot supply power to backup loads.

4.2 PV Connection



WARNING:

- * Ensure the PV module's open-circuit voltage (Voc) **does not exceed 60V** (inverter max. PV input voltage) and is **higher than 25V** (inverter startup voltage). The operating voltage should be within 20V to 60V.
- * Only DC cables certified for PV applications shall be used.
- * Turn off the Main Switch of grid power (AC) before connection.

Model	SUN-BK(80~250)-2.56KWH -AA-AM4-18L	SUN-BK(80~250)-2.56KWH -AA-AM4-32L
PV Input Voltage	42.5V (25V~60V)	
PV Array MPPT Voltage Range	20V~55V	
No. of MPP Trackers	4	
No. of Strings per MPP Tracker	1	

① Select qualified PV cables as required.

Cable Type	Cross Section (mm ²)	
	Range	Recommended Value
Specialized PV DC Cable (Model: PV1-F)	2.5~4.0 (12~10AWG)	2.5 (12AWG)

② Insert PV connectors into the positive (+) and negative (-) DC input terminals of the micro ESS. Connect PV modules as shown in the picture.

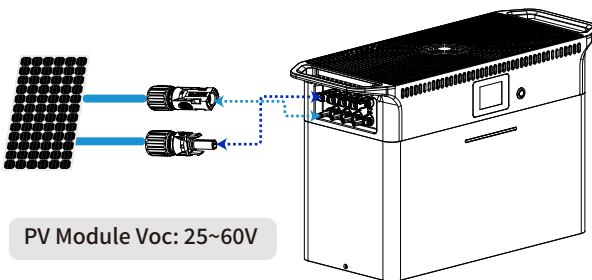

4.3 Grid Connection



WARNING:

- * After connecting the DC connectors, do not turn on the DC switch—leave it in the open position.
- * Do not use one circuit breaker for multiple micro ESS, and do not connect any load between the circuit breakers of different micro ESS.

Model	Cross Section (mm)	Circuit Breaker	AWG	Max. Cable Length
SUN-BK(80~250)-2.56KWH-AA-AM4-18L	2.6	45A/400V	10	External cable (L+N+PE) 20m
SUN-BK(80~250)-2.56KWH-AA-AM4-32L				

Specific instructions are as follows:

The AC output connector consists of four parts: socket, sleeve, sealing ring, and locking nut.

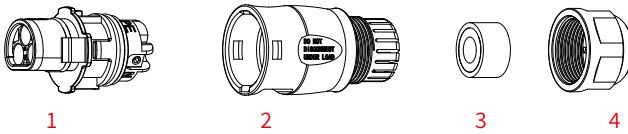

1. Socket; 2. Sleeve; 3. Sealing ring; 4. Locking nut;

- ① Remove the locking nut and sealing ring from the sleeve one by one.
- ② Press the locking tabs inward on the connector body to release and separate the socket from the sleeve.

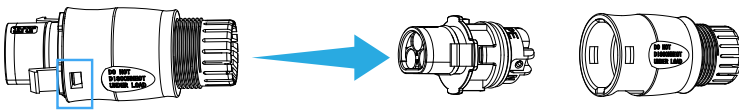

- ③ To prepare the AC cable, please use a wire stripper to remove about 40mm of the outer jacket. Then strip about 8–15mm of insulation from each wire (L, N, PE).

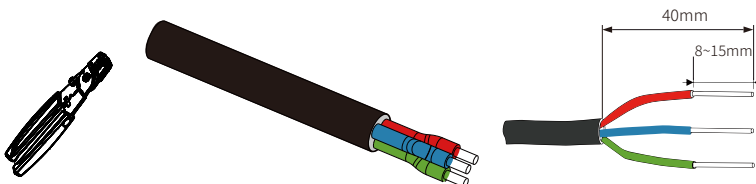

④ Run the L, N, and PE conductors of the cable through the locking nut, then the sealing ring, and finally the sleeve—in that exact order. Make sure all parts are oriented correctly.

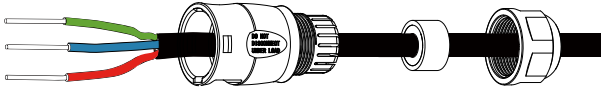

⑤ Use a hex screwdriver to loosen the bolts on the socket. Insert each conductor into its matching hole, then tighten all the bolts securely. Refer to the diagram below for the correct wire orientation inside the AC connector.

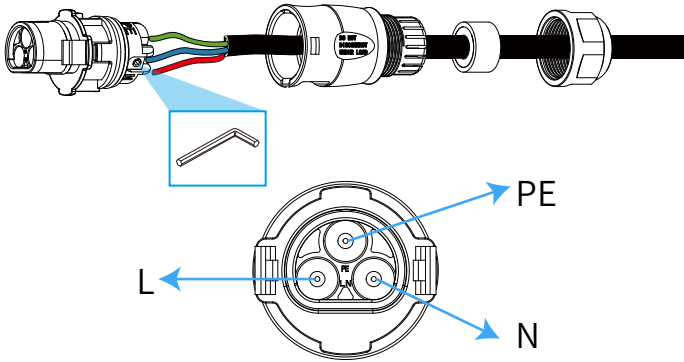

⑥ Slide the sealing ring and the sleeve along the conductors until the sleeve clicks into place on the socket. Ensure the sealing ring fits tightly into the sleeve around the wires. Then, tighten the locking nut.

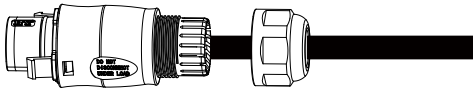

⑦ Remove the waterproof cap from the grid port with the disconnect tool and plug the AC connector into it.

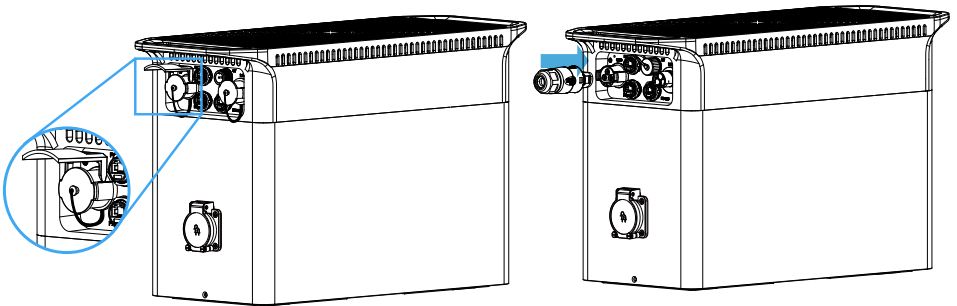

WARNING:

*For outdoor use, the waterproof cap must be inserted into the grid port to prevent water ingress and ensure safe operation.

4.4 Load connection

The load port connector consists of four parts: socket, sleeve, sealing ring, and locking nut.

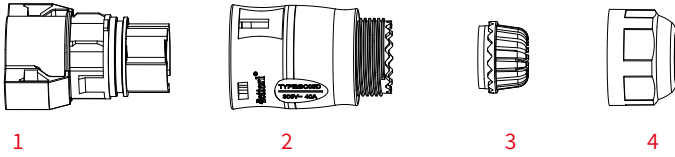

1. Socket; 2. Sleeve; 3. Sealing ring; 4. Locking nut;

- ① Remove the locking nut and the sealing ring from the sleeve one by one.
- ② Press the locking tabs inward on the connector body to release and separate the socket from the sleeve.

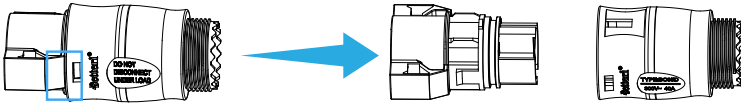

- ③ To prepare the cable, please use a wire stripper to remove about 40mm of the outer jacket. Then strip about 8–15mm of insulation from each wire (L, N, PE).

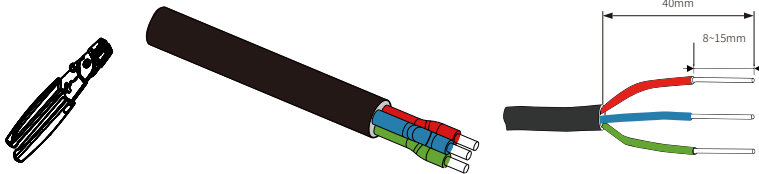

- ④ Run the L, N, and PE conductors of the cable through the locking nut, then the sealing ring, and finally the sleeve—in that exact order. Make sure all parts are oriented correctly.

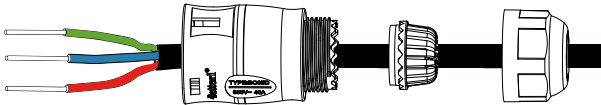

- ⑤ Use a Phillips screwdriver to loosen the bolts on the socket. Insert each conductor into its matching hole, then tighten all the bolts securely. Refer to the diagram below for the correct wire orientation inside the AC connector.

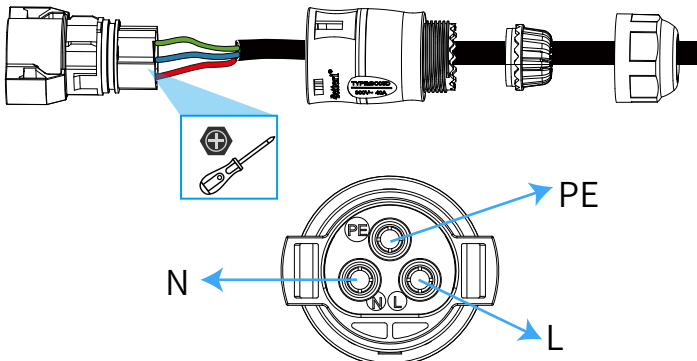

⑥ Slide the sealing ring and the sleeve along the conductors until the sleeve clicks into place on the socket. Ensure the sealing ring fits tightly into the sleeve around the wires. Then, tighten the locking nut.

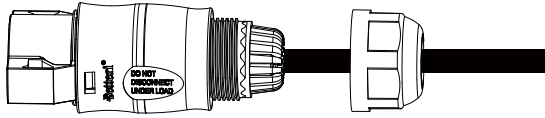

⑦ Remove the waterproof cap from the load port with the disconnect tool and plug the load port connector into it.

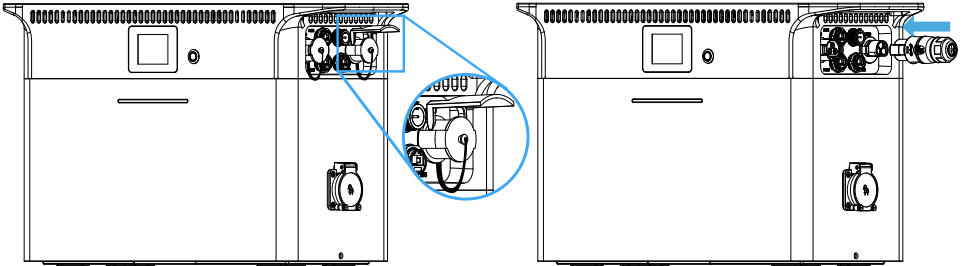

WARNING:

*For outdoor use, the waterproof cap must be inserted into the load port to prevent water ingress and ensure safe operation.

4.5 Parallel Connection (Optional)

Connect the micro ESS using the supplied parallel communication cable by plugging it into the parallel communication ports on each unit and use a hex screwdriver to tighten the locking nut.

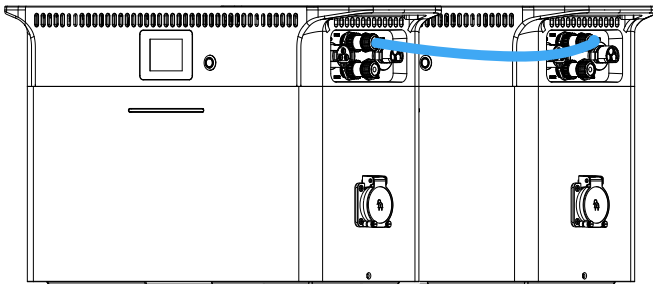

NOTE:

Either parallel port on the unit can be used. There is no port 1 or port 2 distinction.

Single-phase Parallel Wiring Diagram-1

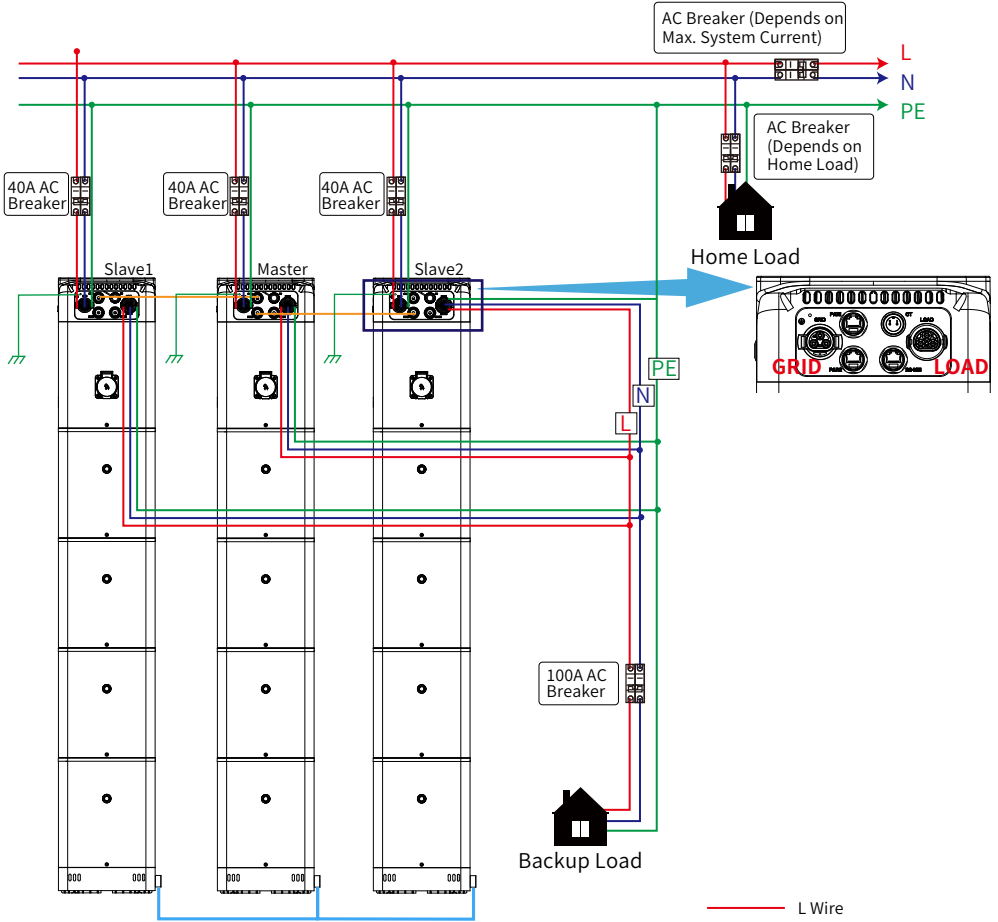

Notes:

1. The micro ESS connected to both other two devices must be set as **Master** to ensure correct communication. For example, in this diagram, the middle micro ESS is the Master, and the other two are Slaves. For detailed mobile app configuration, please refer to Chapter 5.8.
2. AC breaker selection for backup load:
 - * 3 micro ESS: 100A AC breaker
 - * 2 micro ESS: 80A AC breaker
 - * 1 micro ESS: 40A AC breaker

Single-phase Parallel Wiring Diagram-2

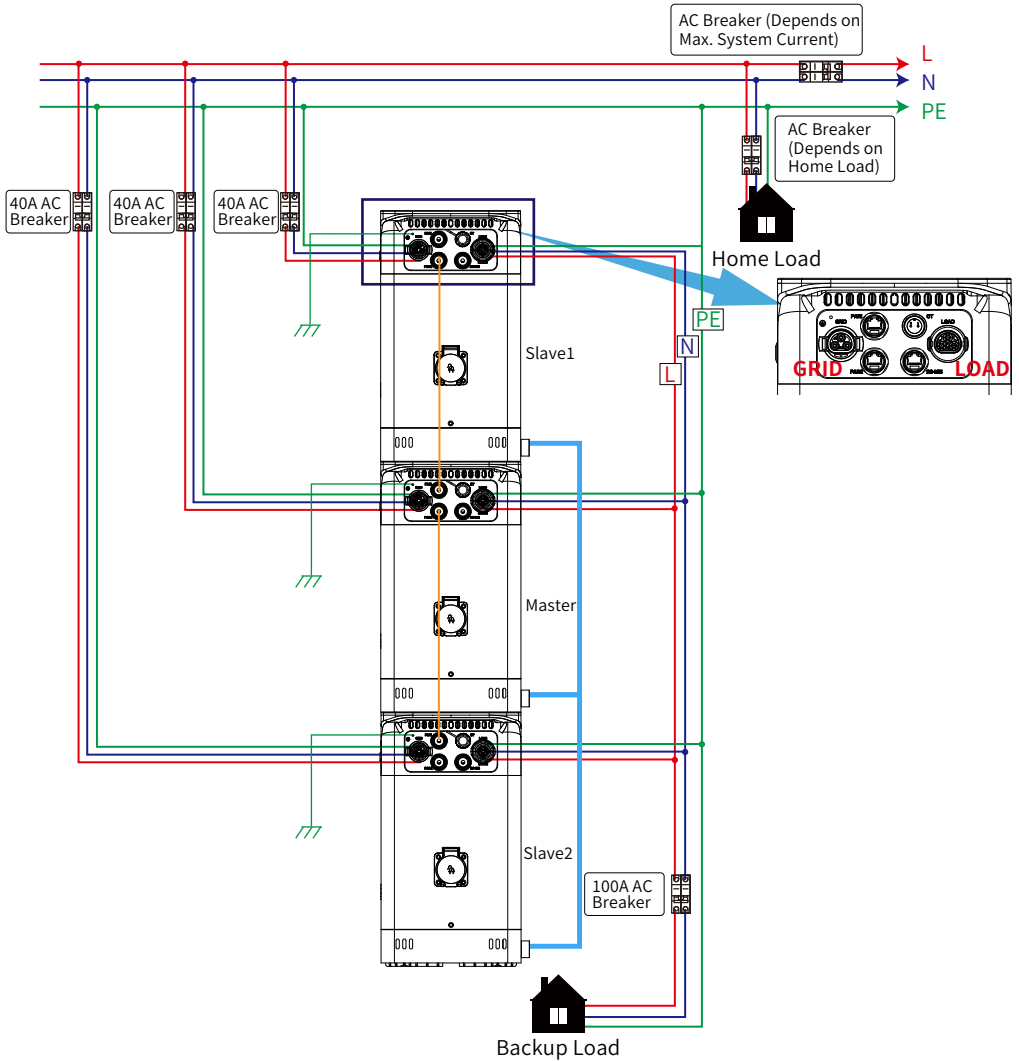

Notes:

1. The micro ESS connected to both other two devices must be set as **Master** to ensure correct communication. For example, in this diagram, the middle micro ESS is the Master, and the other two are Slaves. For detailed mobile app configuration, please refer to Chapter 5.8.
2. Up to 3 **micro ESS** can be stacked. Do not exceed this limit to prevent equipment damage and falling.
3. AC breaker selection for backup load:
 - * 3 micro ESS: 100A AC breaker
 - * 2 micro ESS: 80A AC breaker
 - * 1 micro ESS: 40A AC breaker

- L Wire
- N Wire
- PE Wire
- Inverter Communication Cable
- Battery Communication & Parallel Connection Cable

Three-phase Parallel Wiring Diagram-1

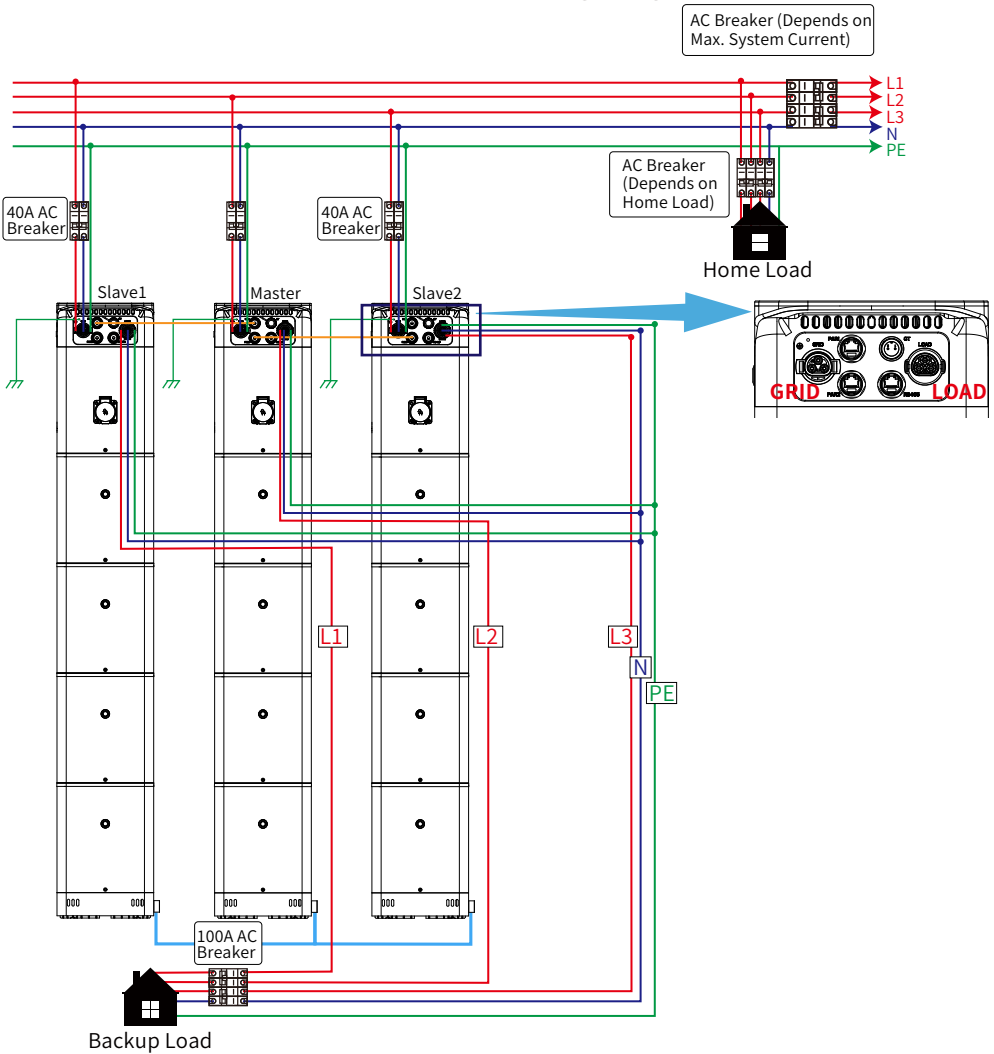

Notes:

1. The micro ESS connected to both other two devices must be set as **Master** to ensure correct communication. For example, in this diagram, the middle micro ESS is the Master, and the other two are Slaves. For detailed mobile app configuration, please refer to Chapter 5.8.
2. AC breaker selection for backup load:
 - * 3 micro ESS: 100A AC breaker
 - * 2 micro ESS: 80A AC breaker
 - * 1 micro ESS: 40A AC breaker

- L Wire
- N Wire
- PE Wire
- Inverter Communication Cable
- Battery Communication & Parallel Connection Cable

Three-phase Parallel Wiring Diagram-2

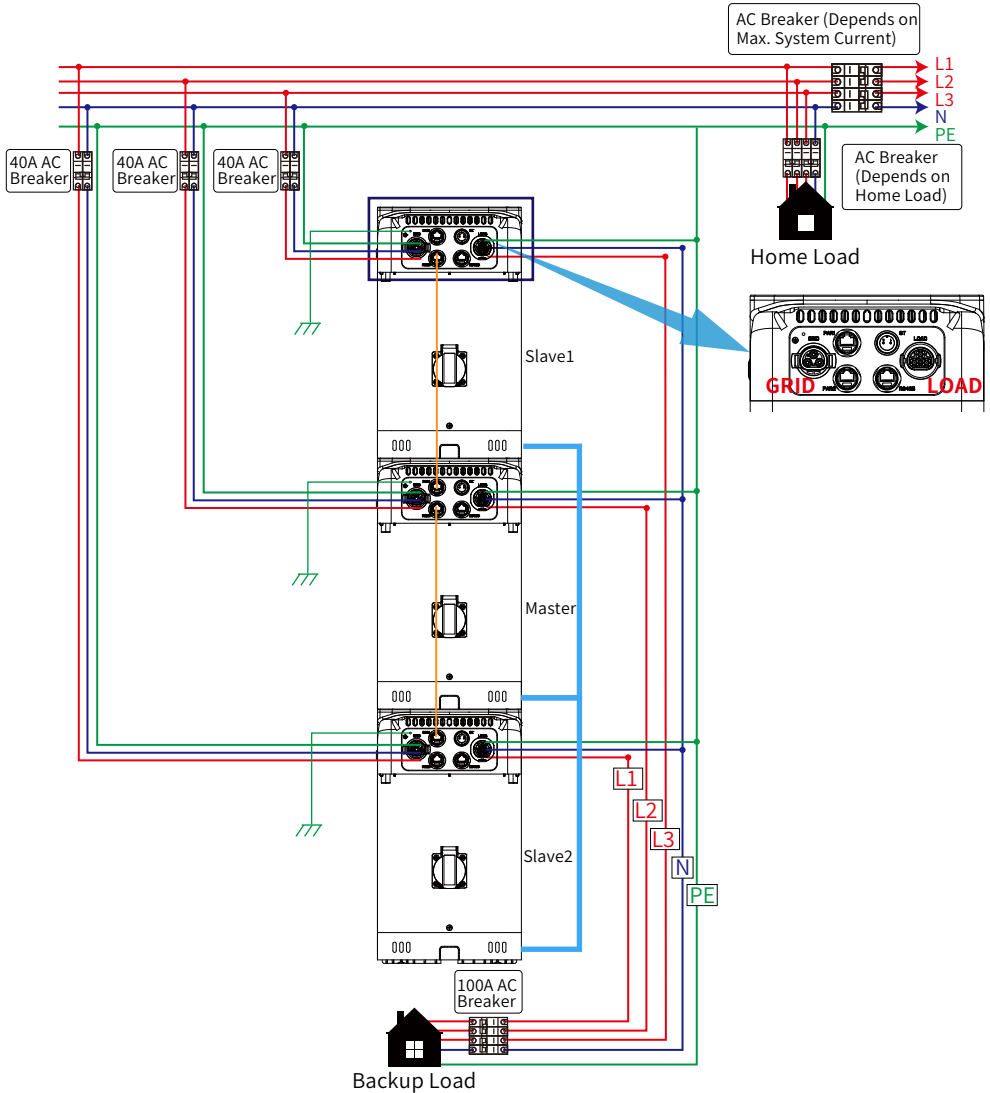

Notes:

1. The micro ESS connected to both other two devices must be set as **Master** to ensure correct communication. For example, in this diagram, the middle balcony ESS is the Master, and the other two are Slaves. For detailed mobile app configuration, please refer to Chapter 5.8.
2. Up to **3 micro ESS** can be stacked. Do not exceed this limit to prevent equipment damage and falling.
3. AC breaker selection for backup load:
 - * 3 micro ESS: 100A AC breaker
 - * 2 micro ESS: 80A AC breaker
 - * 1 micro ESS: 40A AC breaker

- L Wire
- N Wire
- PE Wire
- Inverter Communication Cable
- Battery Communication & Parallel Connection Cable

4.6 Backup Socket



WARNING:

* If no SPD surge protector is installed in the distribution box, do not use the backup socket when the grid port is connected to a home outlet.

- ① Remove two screws from the backup socket.
- ② Open the protective cover and insert the plug of appliances or power strip into the port.

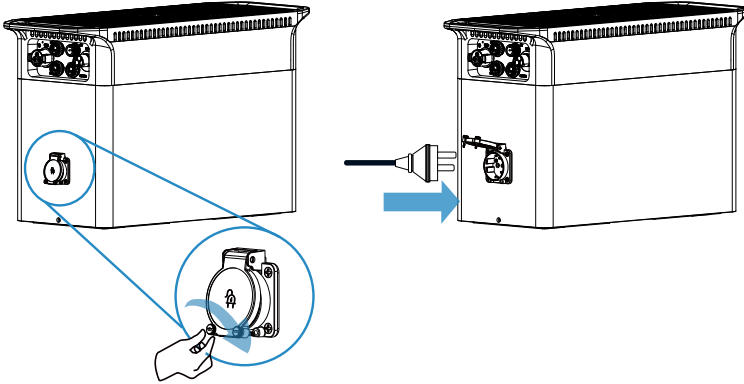

4.7 Earthing Connection

In outdoor off-grid applications, connect a 4.0 mm² (10 AWG) yellow-green stranded copper wire from the grounding screw on the inverter module's metal enclosure to the grounding electrode rod. This ensures reliable grounding of the micro ESS.

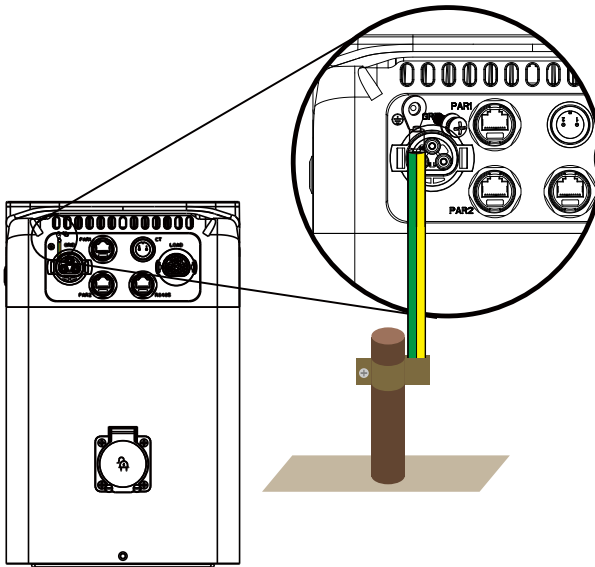

4.8 CT Connection (Optional)

① **Wired CT (Optional & Single-phase only):** if the micro ESS is installed near the distribution box.

Insert the CT lead wire into the CT port and clamp the CT between the micro ESS and the grid, usually on the incoming side of the home main switch.

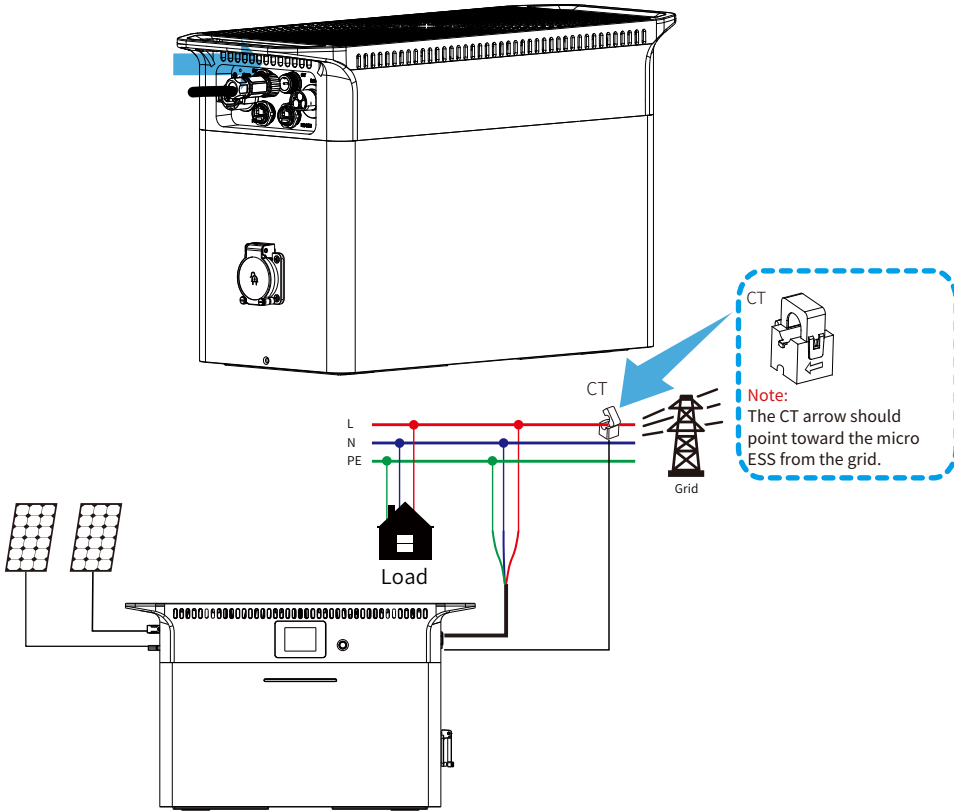

② **Wireless CT (Optional):** if the micro ESS is installed far from the distribution box or wired CT is not feasible.

* Install the smart meter.

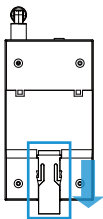

Pull out the clip

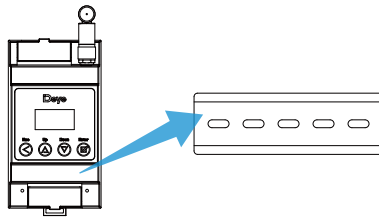

Mount onto the DIN rail

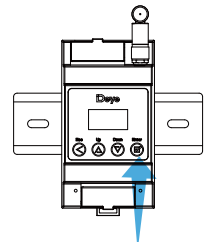

Push the clip back

- * Connect the smart meter's AC terminals to the grid wires inside the distribution box using the recommended AC cable below.
- * Insert the CT lead wire into the CT port on the smart meter, and clamp the CT around the corresponding live wire.

Single-Phase Wireless Smart Meter Connection

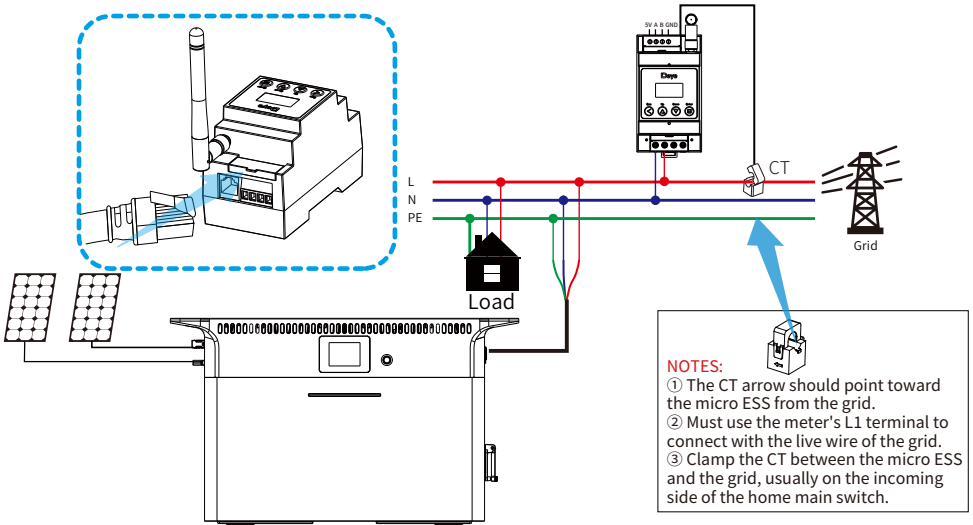

Three-Phase Wireless Smart Meter Connection

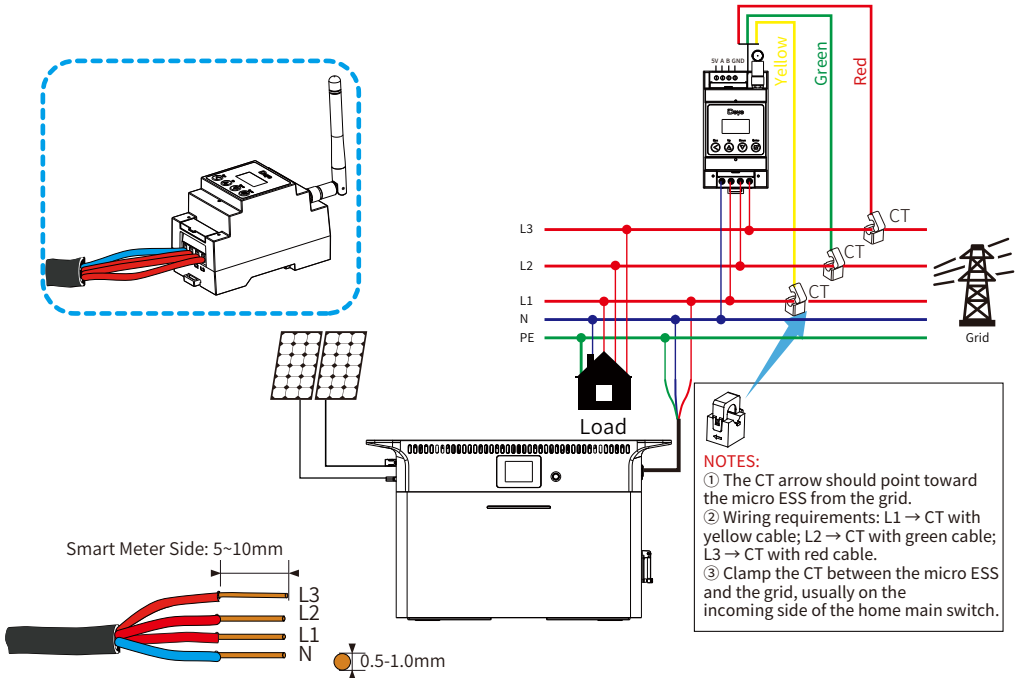

4.9 RS485 Connection (Optional)

① The RS485 communication connector consists of five parts: gasket, main body, locking nut, tail clamp, mounting nut.

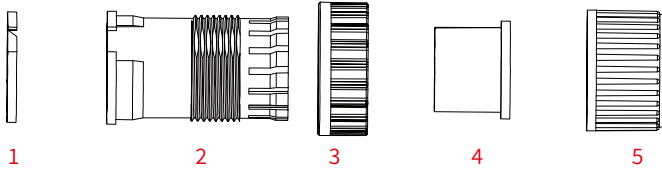

② Remove the locking nut, tail clamp, and mounting nut from connector one by one.

③ Insert the cable into the mounting nut. Open the tail clamp and attach to cable.

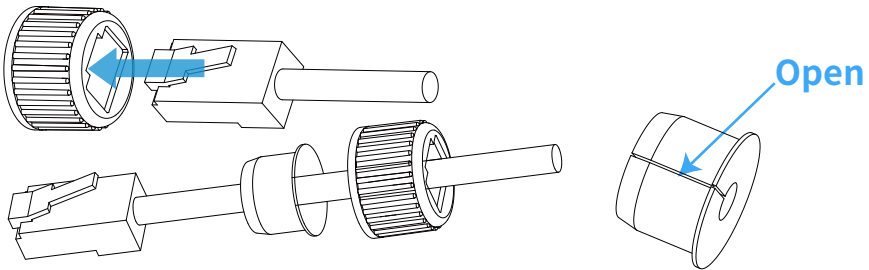

④ Insert the cable into the main body and then insert the crystal head into the RS485 port on the micro ESS. Note that the arrow should face upward during assembly.

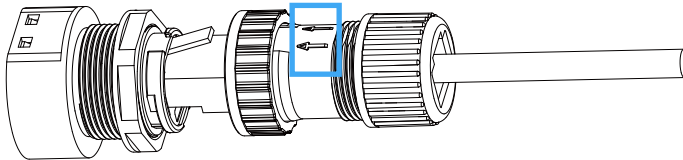

⑤ Push the tail clamp into the main body until it clicks securely into place. Once the clamp is in place, use a hex screwdriver to tighten the locking nut.

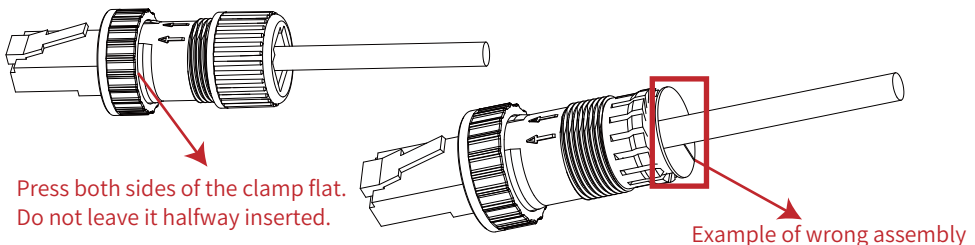

⑥ Remove the waterproof cap from the RS485 port and plug the prepared cable into it.

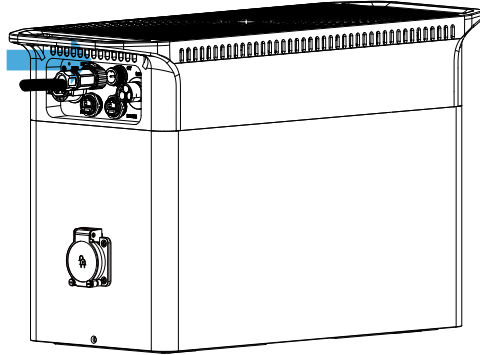

5. System Configuration

5.1 Power On

Press the micro ESS power button to power on (or off). After it is powered on, the LED indicator and LCD screen will light up. The LCD screen will automatically dim after 2 minutes of no activity and will light up again when there is any operation or alarm.

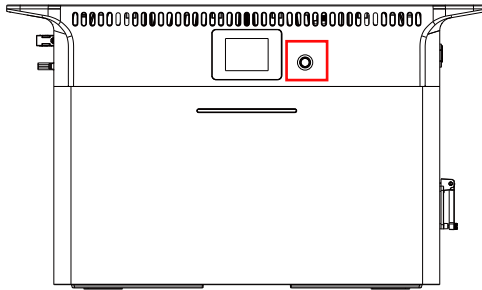

5.2 Download the app

Scan the QR code below to download the app or search "Deye Cloud" in app store (iOS) or Google Play Store (Android). Install the app on your mobile phone.



Google Play and the Google Play logo are trademarks of Google LLC.



Apple, the Apple logo, and App Store are trademarks of Apple Inc., registered in the U.S. and other countries and regions.

5.3 Register an Account

- 1 Read the information on the pop up window and click "I agree" and then click "Register account".

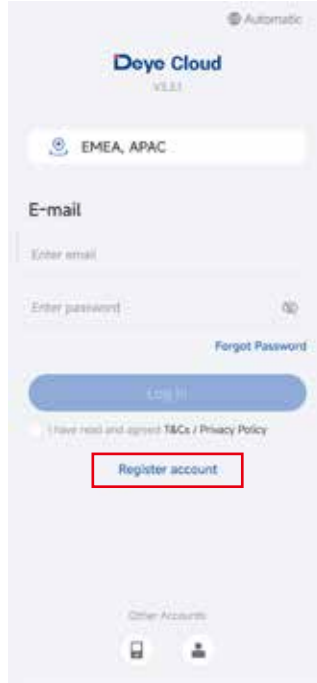
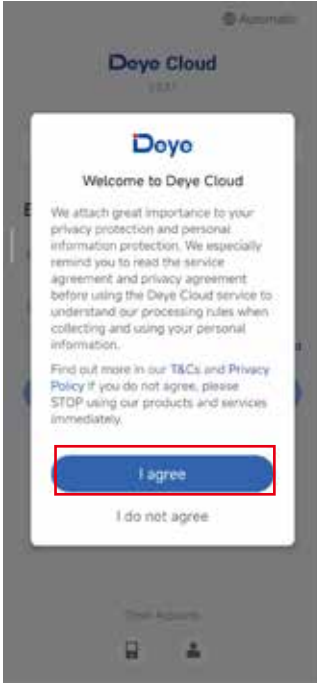

② Select data center, enter your email address, and check "Terms of Service" and "Privacy Policy". Enter the verification code, set the password and click "Confirm" to create a new account.

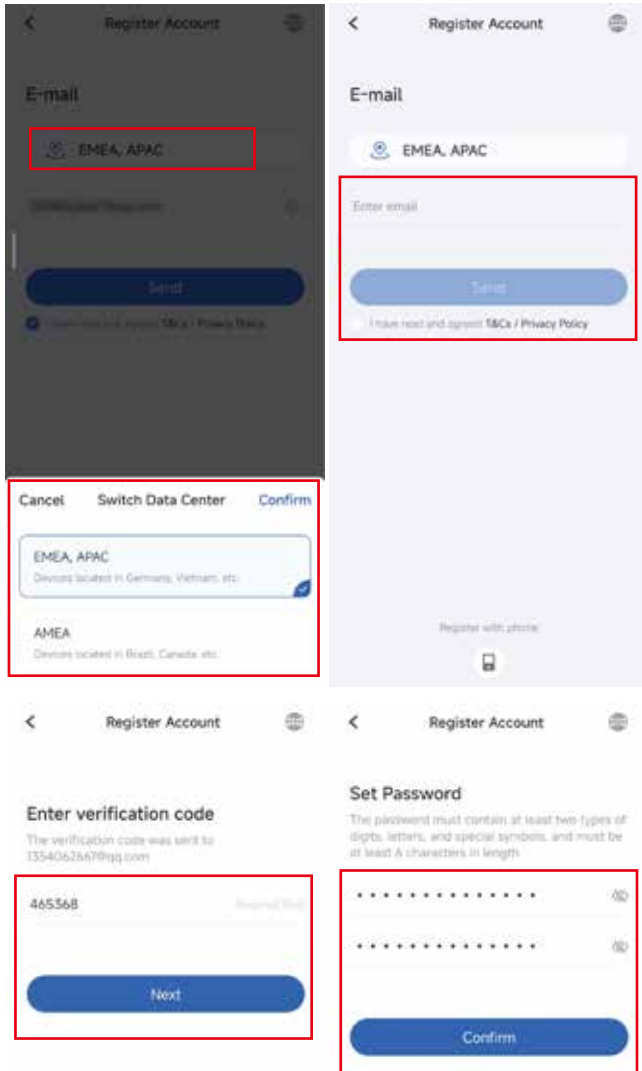

5.4 Create the Plant

① Close the pop window and create a new plant at the top right of this page. Enter the information like plant name, plant address, system type, system capacity and click "Confirm".

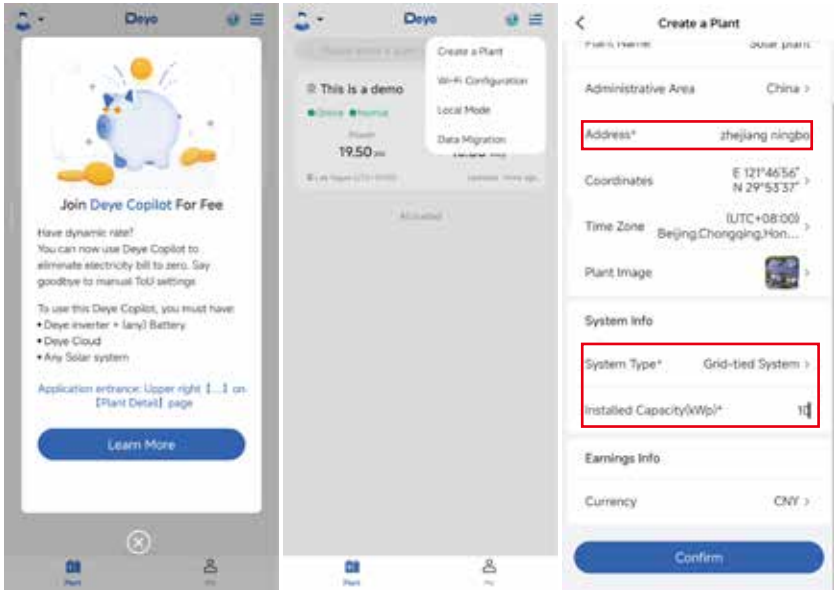

② Click "Add now" and choose to scan the QR code or enter the logger's SN manually. Find the QR code and the logger's SN on the name plate of the micro ESS as shown below. Click "Confirm" to complete.

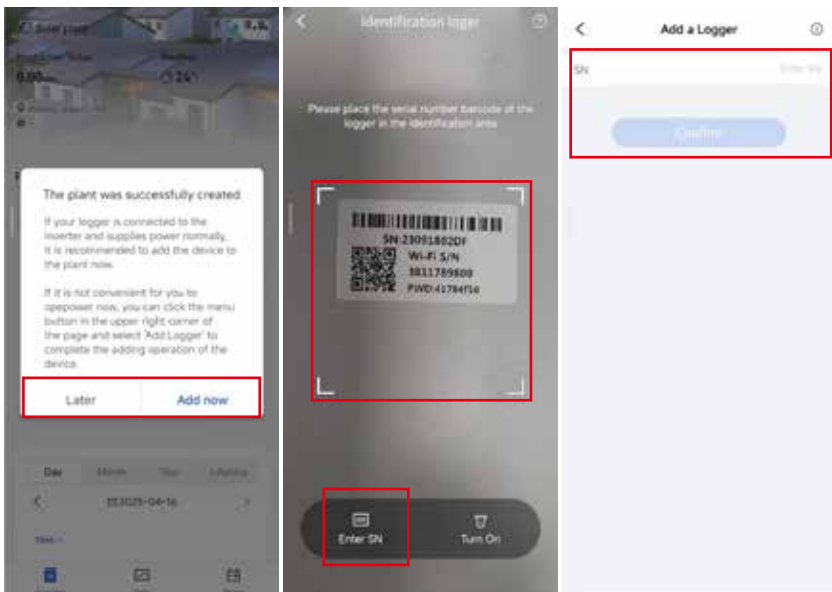

5.5 Network Configuration

① Select "Later" on the pop up window, return to the home page, and turn on Bluetooth of the mobile phone. Click the "☰" icon in the top right corner, select "Wi-Fi Configuration", and the app will scan for nearby devices automatically.

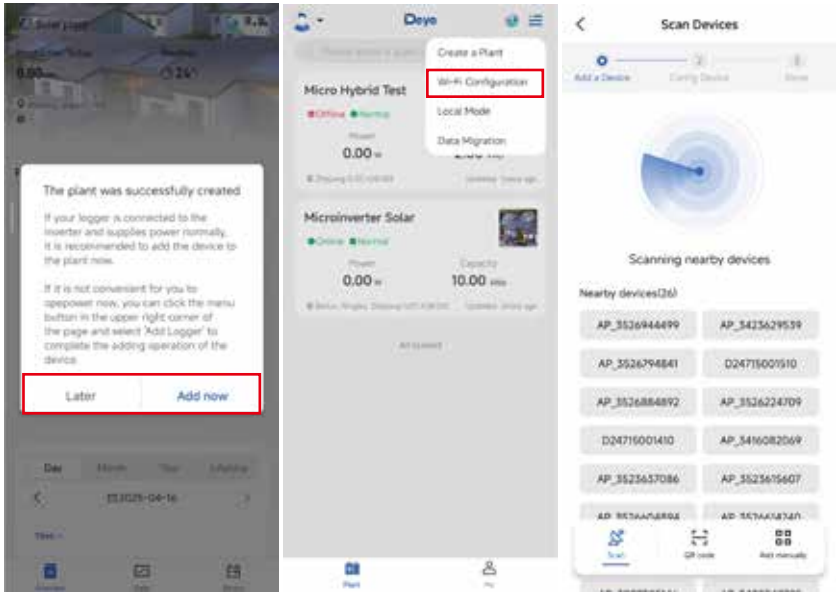

② Select the AP network of the micro ESS you want to connect. Choose a 2.4G Wi-Fi network, enter the password, and click "Next". Find the AP network name on the name plate of the micro ESS.



Note:
The Wi-Fi SN is on the nameplate of the micro ESS.

③ The Wi-Fi setup will begin. Please stay on this page and keep your phone close to the device. Once the setup is complete, you can name the device. Click "Complete" to finish.

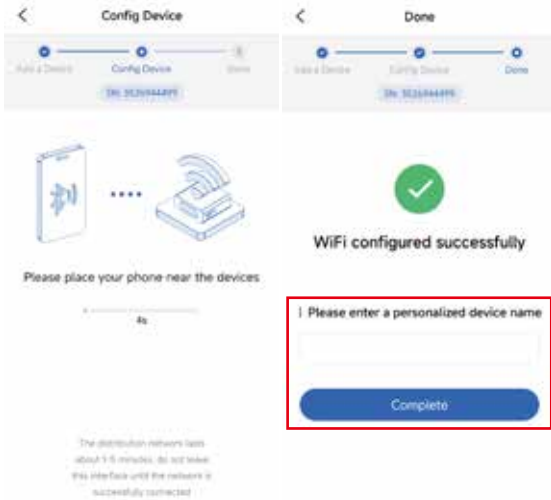

Notes:

- ① Make sure your Wi-Fi network is 2.4 GHz, as the micro ESS only supports 2.4 GHz network now.
- ② Expansion batteries are auto-recognized. Connect them and the system will add them automatically.

5.6 Setup Smart Devices

- ① On the plant page, click "Device" at the bottom right to enter the device page.
- ② Click "Smart Device", then click the "+" icon to add a new device.

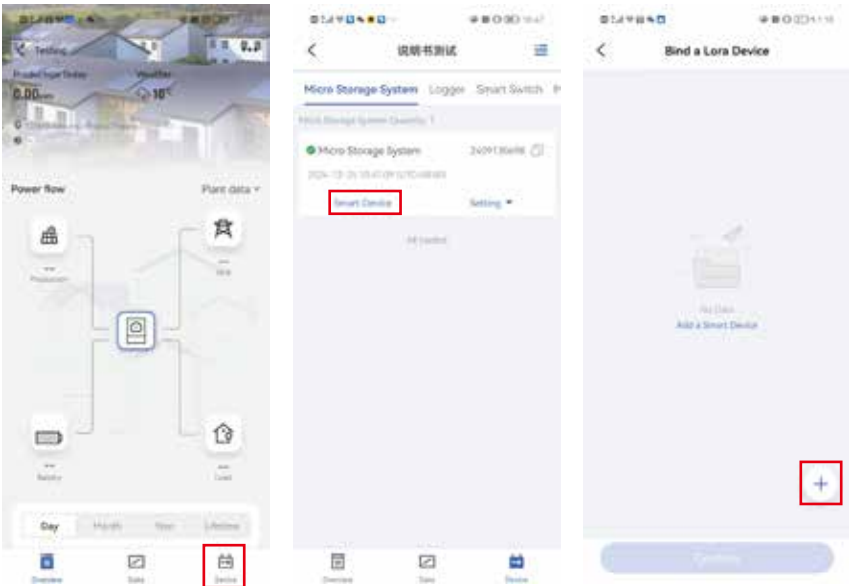

- ③ Scan the QR code on the device or manually enter its SN.
- ④ Select the device type and click "Confirm" to complete the binding.

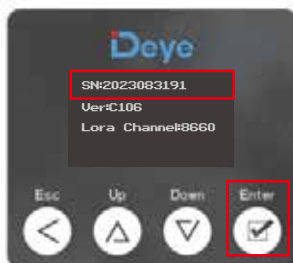
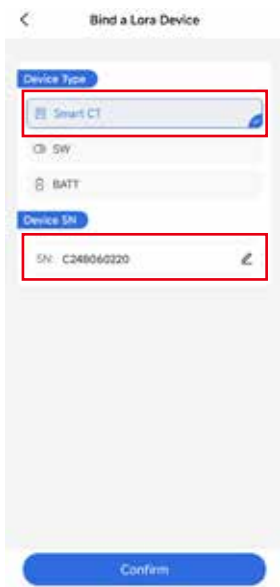

E.G.: Smart Meter's SN

- ⑤ E.G.: If a smart meter is added, perform a channel scan on the meter to establish LoRa communication with the micro ESS.



5.7 Setup Work Mode

Refer to the tables below for system settings based on different user requirements:

- **Scenario 1** - Prioritize self-consumption for daily use, then choose whether to export to the grid based on actual needs and local regulations:

Deye Cloud App Settings		On Grid + Self-consumption	
		Home Load > ESS Charge > Export to Grid	Home Load > ESS Charge, No Export to Grid
Storage Inverter Work Mode 1	System Work Mode	Green Power Mode	
	Energy Management Model	Load First Mode	
	Limit Control Function	Zero Export to CT / Zero Export to Wireless CT	
	Solar Sell On	Enable	Disable
	Grid Charging Enable	Default: Enable (Fixed)	
Storage Inverter Work Mode 2	Time of Use (TOU)	Default: Enable (Fixed)	
	Grid Charge under TOU	Default: Disabled (Fixed)	

- **Scenario 2** - When you need to quickly charge the micro ESS before using it as backup or portable power:

Deye Cloud App Settings		On Grid	
		ESS Charge > Home Load > Export to Grid	ESS Charge > Home Load, No Export to Grid
Storage Inverter Work Mode 1	System Work Mode	Full Charge Mode	
	Energy Management Model	No Setting Required	
	Limit Control Function	Zero Export to CT / Zero Export to Wireless CT	
	Solar Sell On	Enable	Disable
	Grid Charging Enable	Default: Enable (Fixed)	
Storage Inverter Work Mode 2	Time of Use (TOU)	Default: Disabled (Fixed)	
	Grid Charge under TOU		

• **Scenario 3** - When you want to configure freely according to local TOU (Time-of-Use) electricity prices and user requirements:

Deye Cloud App Settings		On Grid
Storage Inverter Work Mode 1	System Work Mode	Customized Mode
	Energy Management Model	Setup based on user needs. For details, refer to the full user manual.
	Limit Control Function	
	Solar Sell On	
Grid Charging Enable		
Storage Inverter Work Mode 2	Time of Use (TOU)	Enable, setup based on user needs
	Grid Charge under TOU	

• **Scenario 4** - When the micro ESS is used as backup power or a portable power source currently, the system always prioritizes load supply by default, regardless of app settings.

5.8 AC Couple Setting AC Couple on Grid Side

① Refer to the diagram below to complete the system installation first:

Single phase

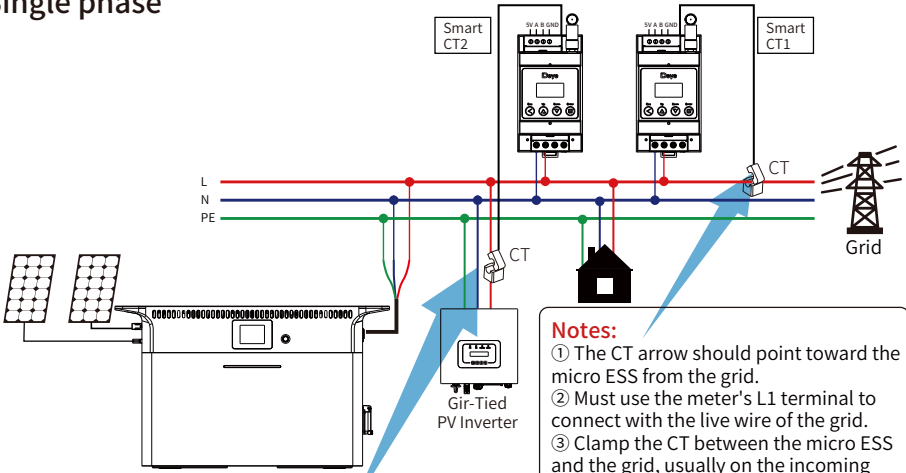

Notes:

- ① The CT arrow should point toward the grid-tied PV inverter from the grid.
- ② Must use the meter's L1 terminal to connect with the live wire of the grid.
- ③ Clamp the CT between the inverter and the grid, usually on the branch circuit of the grid-tied inverter.

Notes:

- ① The CT arrow should point toward the micro ESS from the grid.
- ② Must use the meter's L1 terminal to connect with the live wire of the grid.
- ③ Clamp the CT between the micro ESS and the grid, usually on the incoming side of the home main switch.

Three phase

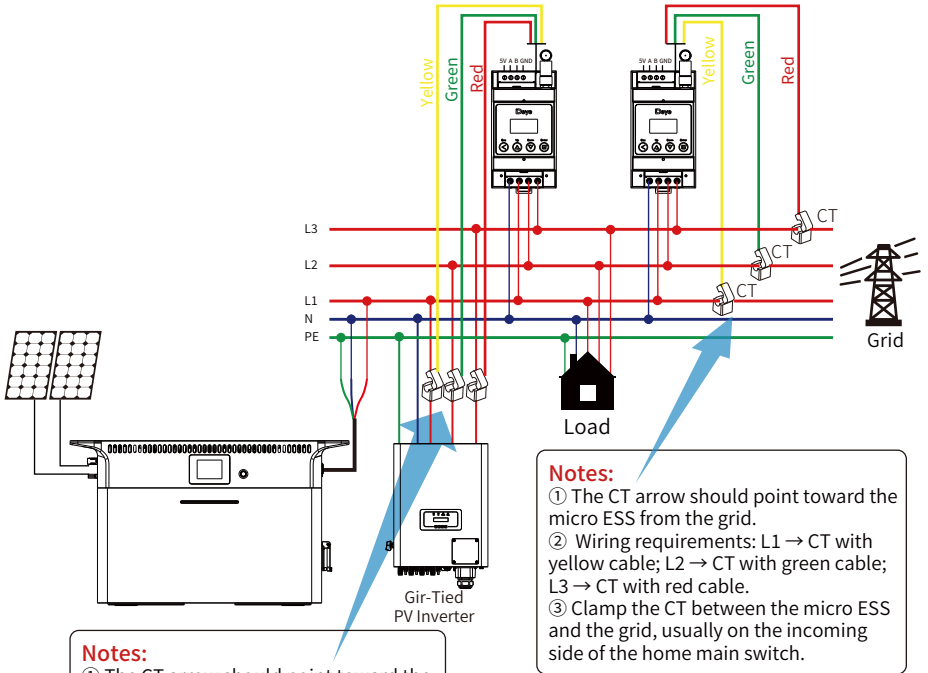

Notes:

- ① The CT arrow should point toward the grid-tied PV inverter from the grid.
- ② Wiring requirements: L1 → CT with yellow cable; L2 → CT with green cable; L3 → CT with red cable.
- ③ Clamp the CT between the inverter and the grid, usually on the branch circuit of the grid-tied inverter.

② Refer to Chapter 5.6 to add **TWO** smart CTs to the plant and establish LoRa communication between the micro ESS and smart CTs.

③ Set system work mode based on actual demands.

***Green Power Mode:** Designed mainly for self-consumption. In this mode, the grid-tied inverter does not charge the battery under any circumstances.

***Full Charge Mode:** Prioritizes battery charging. The grid-tied inverter will charge the battery when PV generation produces surplus power.

***Customized Mode:** Users can set different strategies under 6 time periods.

- During the current time period, if the user wants to charge the battery using grid energy, the battery's target SOC should be set to a high value (e.g., 100%).

- During the current time period, if the user does not want to use grid energy to charge the battery (Micro ESS primarily utilizes photovoltaic power and battery energy), the target SOC of the battery should be set to a low value (e.g., 20%).

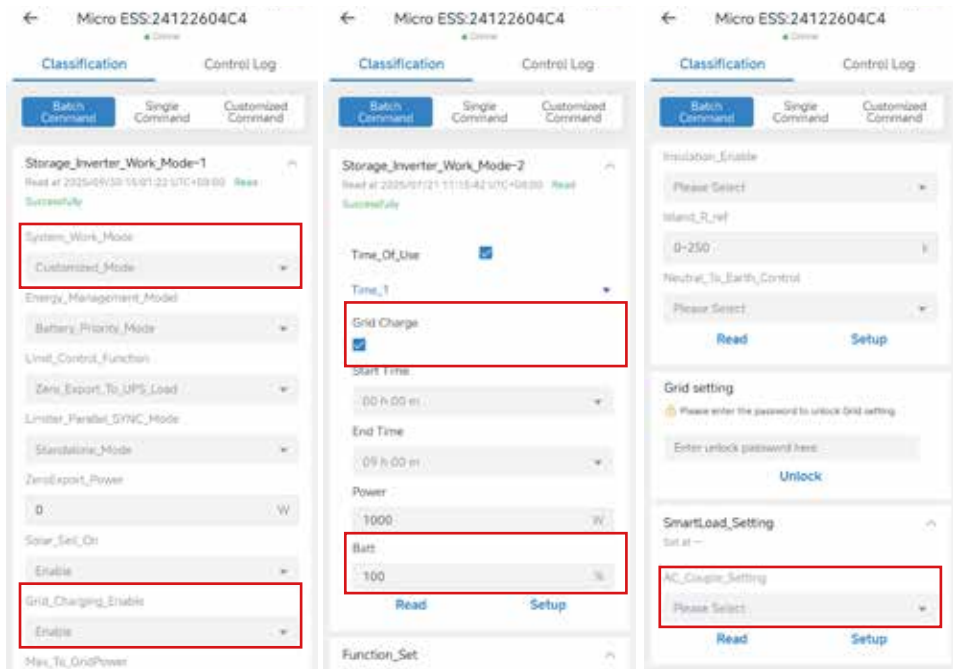

Note: For detailed App setup guide, please refer to **Chapter 6**.

6. Deye Cloud Operating Instructions

6.1 Battery Setting

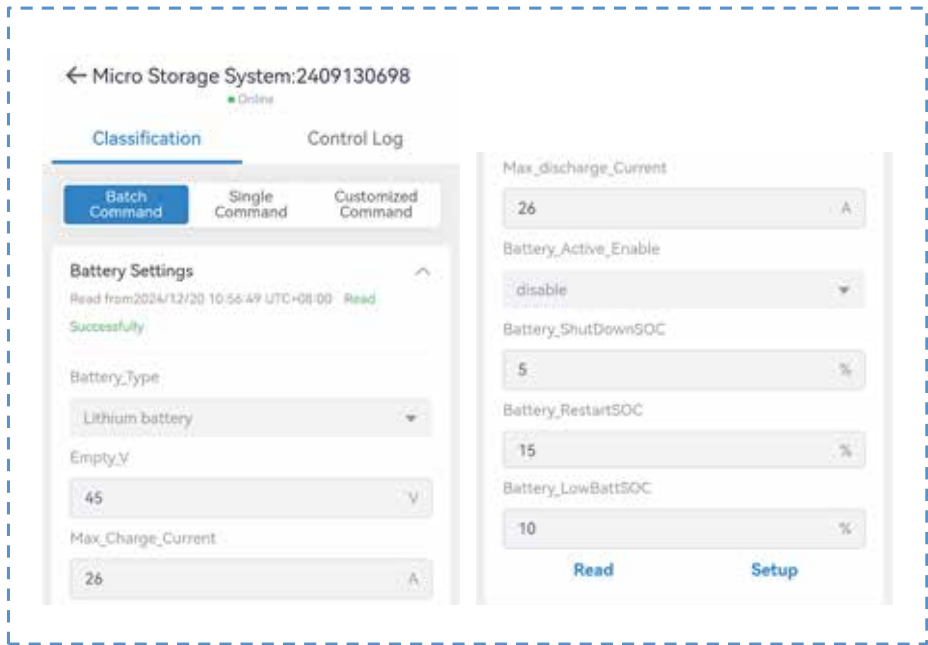

① Battery_Type:

Range: Lead-Battery / Lithium Battery / No Battery. Note: For micro ESS, select "Lithium Battery".

② Empty_V:

Range: 0.01~60.00 V. The voltage level at which the battery is considered fully discharged.

③ Max_Charge_Current:

Range: 0.00~55.00 A. The upper limit of the current allowed during charging.

④ Max_Discharge_Current:

Range: 0.00~55.00 A. The upper limit of the current allowed during discharging.

⑤ Battery_Active_Enable:

Range: Enable / Disable. When enabled, the system will activate an over-discharged battery using a small current.

⑥ Battery_ShutDownSOC:

Range: 0~100%. In off-grid mode, when the battery SOC falls below this value, the inverter will trigger low SOC protection and shut down the DC/AC conversion to stop AC output.

⑦ Battery_RestartSOC:

Range: 0~100%. In off-grid mode, when the battery SOC recovers to this value, the inverter will resume AC output by restarting the DC/AC conversion module.

⑧ Battery_LowBattSOC:

Range: 0~100%. In on-grid mode, when the battery SOC drops to this value, low SOC protection is triggered. The inverter will stop discharging to maintain the SOC above this threshold.

6.2 Storage Inverter Work Mode-1

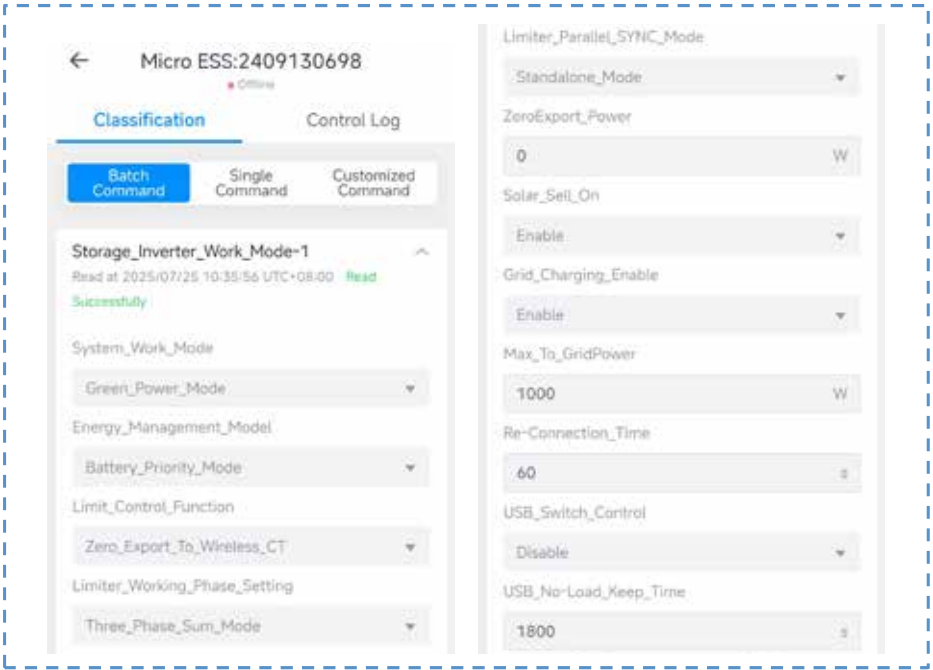

① System_Work_Mode:

Green Power Mode: Solar and battery energy are mainly used locally. The battery can only be charged by PV power, which means grid charging is not allowed. Excess power can be also be sold to the grid if allowed.

Full Charge Mode: Fully charge the battery using solar or grid power before portable use. Excess power can also be sold to grid if allowed.

Customized Mode: Charge or discharge the battery according to the Time-of-Use (TOU) settings.

② Energy_management_model:

Battery Priority Mode: PV energy is prioritized for charging the battery.

Load First Mode: PV energy is prioritized for powering connected loads.

③ Limit_control_function:

Sell First: Allows power to be exported to the grid.

Zero Export to UPS Load: The inverter's AC output only powers backup loads connected to the load port of the micro ESS.

Zero Export to CT: Limits inverter output to prevent excess power from feeding into the grid, using a wired external CT.

Zero Export to Wireless CT: Limits inverter output to prevent excess power from feeding into the grid, using a wireless smart meter and several CTs.

④ **Limiter_Working_Phase_Setting (Zero Export to Wireless CT only)**

Single Phase Mode: Ensure zero export to the grid on the phase where the wireless CT is installed.

Three Phase Sum Mode: Ensure zero export to the grid for the total of all three phases.

⑤ **Limiter_Parallel_SYNC_Mode:**

Standalone_Mode: Each installed CT/smart meter independently controls the anti-backflow function of its corresponding micro ESS.

SYNC_Mode: A single CT/smart meter system controls the anti-backflow function of multiple micro ESS via wireless data communication.

⑥ **ZeroExport_power:**

Range: 0~100 W. Defines the power to be imported from the grid to offset potential CT measurement errors and prevent unwanted grid feed-in.

⑦ **Solar_sell_On:**

Range: Enable / Disable. Enables or disables selling excess solar power to the grid.

⑧ **Grid_charging_Enable:**

Range: Enable / Disable. Enables or disables charging the battery using grid power.

⑨ **MaxToGridPower:**

Range: 0~1000 W. Sets the maximum power that can be fed into the grid.

⑩ **Re-connection_time:**

Range: 10~3000 seconds. Specifies the delay time for inverter reconnection after grid recovery.

⑪ **USB_Switch_Control:**

Range: Enable / Disable. Defines whether the USB port power switch controls the ON/OFF status of the USB output.

⑫ **USB_No-Load_Keep_Time:**

Range: 300~1800 seconds. Turns off USB output after the port remains idle for the set duration.

6.3 Inverter System Settings

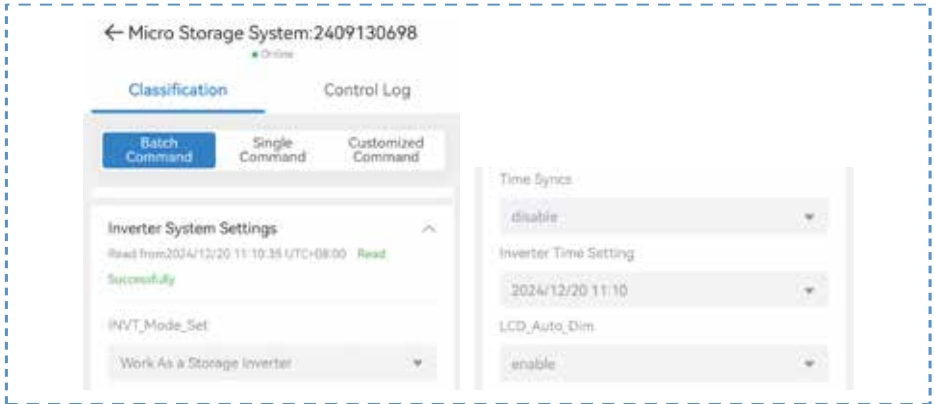

① INVT_Mode_Set:

Work as a Storage Inverter: Operates as a hybrid inverter with energy storage capability.

② Time Syncs:

Range: Enable / Disable. When enabled, the ESS time will automatically synchronize with the cloud platform once the system is online.

③ Inverter Time Setting:

Allows manual setting of the local system time for the ESS.

④ LCD_Auto_Dim:

Range: Enable / Disable. When enabled, the LCD screen will automatically dim after 2 minutes of inactivity.

6.4 Storage Inverter Work Mode-2

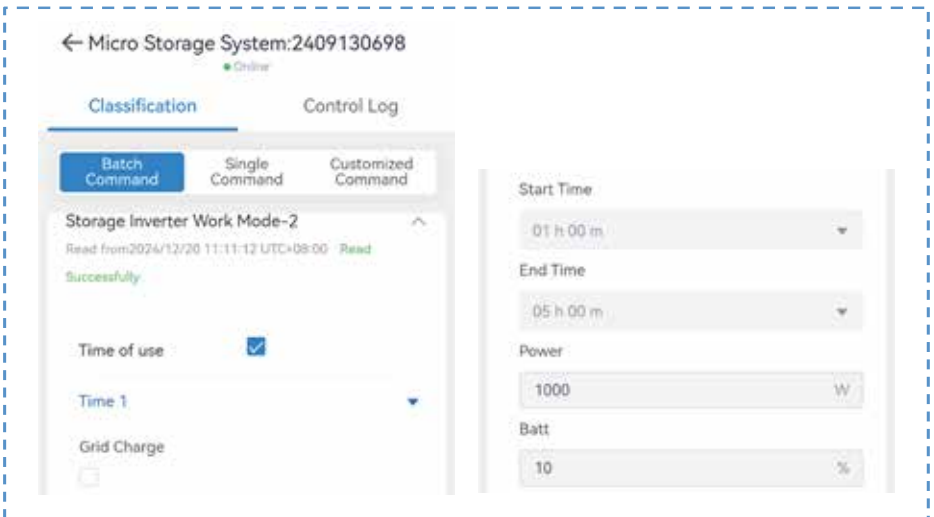

① Time of use:

Manages battery charging and discharging based on a user-defined schedule.

② Time 1/2/3/4/5/6:

Up to six configurable time periods are available.

③ Grid Charge:

Defines whether grid power is allowed to charge the battery during the selected time period.

④ Start Time:

Specifies the starting time of the time period.

⑤ End Time:

Specifies the ending time of the time period.

⑥ Power:

Range: 0~1000 W. Sets the maximum discharging power limit for the time period.

⑦ Batt:

Range: 0~100%. Defines the target SOC during the time period. If the actual SOC is above the set value, the battery is allowed to discharge. If the actual SOC is below the set value, the battery will charge until the target is reached.

6.5 Function Set

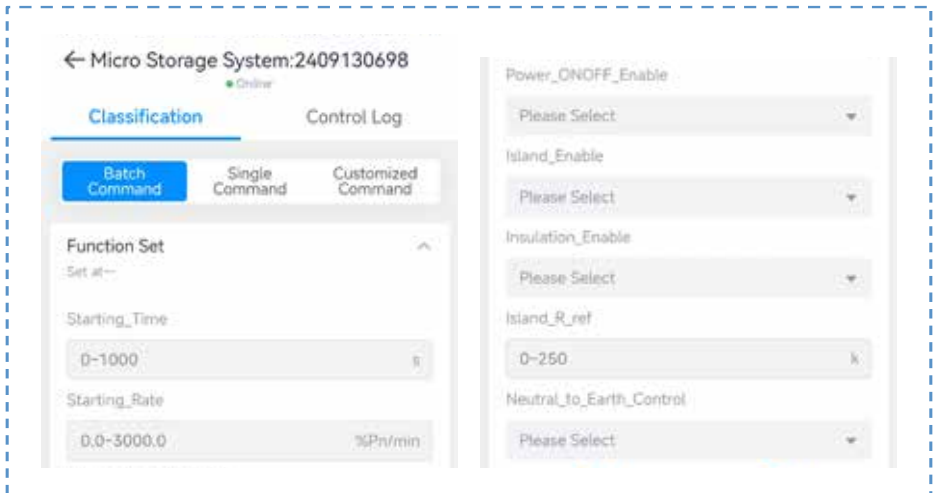

① Starting_Time:

Range: 0~1000 seconds. The time required to start up the inverter module of the ESS.

② Starting_Rate:

Range: 0.0~3000.0 %Pn/min. The ramp-up rate of output power when the inverter starts, expressed as a percentage of the rated power.

③ Power_ONOFF_Enable:

Range: Switch On / Switch Off. Allows the inverter module of the ESS to be remotely powered on or off via the mobile app.

④ Island_Enable:

Range: Enable / Disable. Enables or disables the anti-islanding protection function of the ESS.

⑤ Insulation_Enable:

Range: Enable / Disable. Enables or disables the insulation resistance monitoring function.

⑥ Island_R_ref:

Range: 0~250 Ω. The lower threshold value used to evaluate whether the insulation resistance of the ESS is within the safe range.

⑦ Neutral_to_Earth_Control:

Range: Enable / Disable. In off-grid mode, the N and PE wires are connected together to achieve grounding when enabled.

6.6 Smart Load Setting

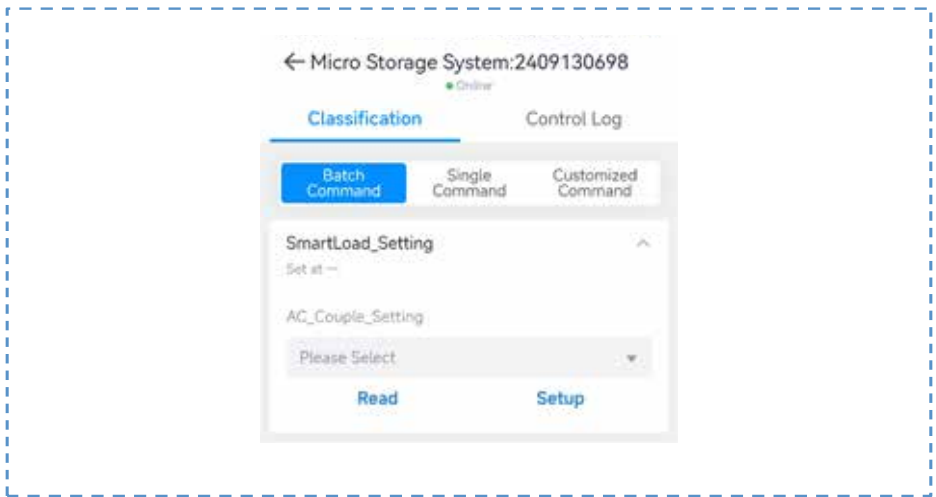

AC_Couple_Setting:

Disable_AC_Couple: The AC coupling function is disabled.

AC_Couple_On_Grid_Side: The micro ESS connects in parallel with an external grid-tied PV inverter on the grid side.

AC_Couple_On_Load_Side (In Development): An external grid-tied PV inverter is connected to the Load port of the micro ESS.

Notes:

* Grid settings are intended for qualified professionals only. Please contact your distributor before unlocking or modifying these settings.

* Available options and setting ranges may vary depending on the product model.

7. Expansion Batteries

7.1 Technical Data

Model	AE-F2.56
Battery Technical Specifications	
Battery Chemistry	LiFePO ₄
Battery Nominal Voltage (V)	51.2
Battery Nominal Energy (Wh)	2560
Max. Charging/Discharging Current (A)	50
Battery Operating Voltage (V)	44.8-57.6
Battery Cycle Life	≥6,000 (@25°C±2°C, 70%EOL)
Max. Stack NO.	5 pcs (up to 12.8kWh)
Parallel Capability	40 pcs (up to 102.4kWh)
Other Technical Specifications	
Display	LED (SOC, Alarm)
Communication	LoRa
Dimension (WxDxH) (mm)	450x210x244 (without terminals)
Ingress Protection (IP) Rating	IP65
Weight Appr. (kg)	22±3
Operating Temperature Range	-10°C~55°C (-20°C~55°C with heating, optional)
Max. Operating Altitude	2,000m
Permissible Ambient Humidity	0-95%
Certification	UN38.3, IEC62619, CE
Installation Style	Floor-Mounted, Stacked-Mounted
Warranty	10 years

7.2 Installation

This micro ESS uses plug-in connections for battery expansion, allowing for easy installation. A total of 4 expansion batteries are supported, with a maximum total battery capacity of 12.8 kWh. For detailed steps, please refer to **Chapter 3**.

8. Applications

8.1 On Grid

PV modules + Micro ESS + Expansion battery (Optional)

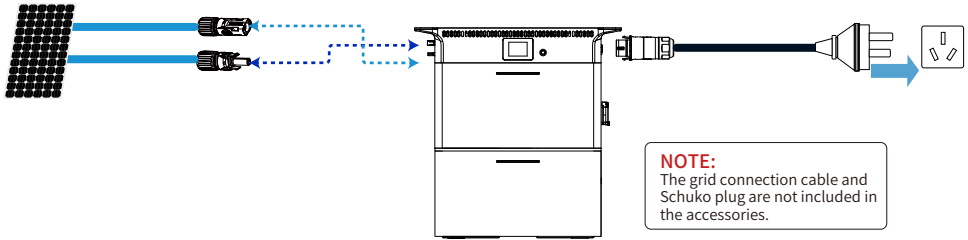

8.2 Off Grid

① PV modules + Micro ESS + Expansion battery (Optional)

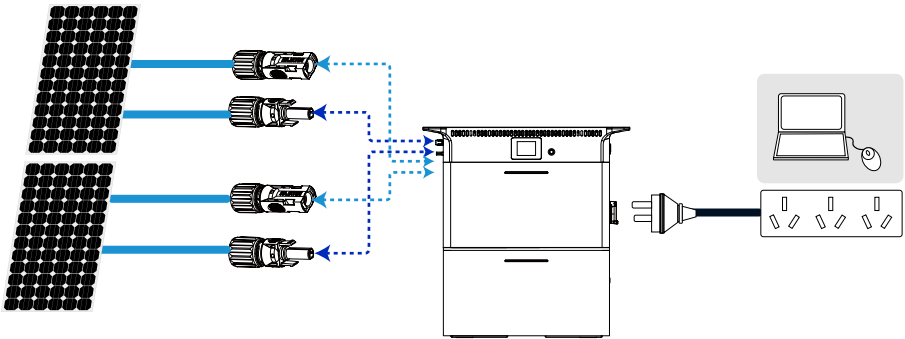

② Micro ESS + Expansion battery (Optional)

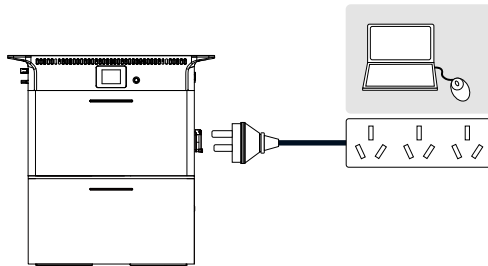

9. FAQs and Troubleshooting

9.1 FAQs

① What type of battery does the product use? Is it safe?

This product uses a high-quality lithium iron phosphate (LiFePO₄) battery. The system is designed with multiple protection features to ensure safe and stable operation, including protections against undervoltage, overvoltage, overcurrent, low temperature, and high temperature.

② How can I tell if the system is charging or discharging?

When the system is charging or discharging: The LCD screen will show the remaining time. The power icon next to the battery percentage will rotate in a circle and show input/output power. The LED light will flash during both charging and discharging.

③ Can the system charge and discharge at the same time?

Yes, the system can charge and discharge simultaneously. However, long-term use in this mode may cause damage to the product.

④ How do I clean the product?

Use a dry, soft, clean cloth or tissue to gently wipe the surface. Do not use water, chemicals, or cleaning sprays.

⑤ How do I store the product?

Turn off the power first and store the product in a dry, well-ventilated area at a suitable temperature. Avoid environments that are damp, dusty, high-temperature, or have high salt content, as these may damage the product. For long-term storage, it is recommended to discharge the battery to about 50% SOC every month, and then recharge it to 100% SOC to help extend the product's lifespan.

9.2 Troubleshooting for Inverter Module

Fault Code	Definitions	Solutions
F01	DC_Inversed Failure	Reserved.
F02	DC_Insulation_Failure	Reserved.
F03	GFDI_Failure	Reserved.
F04	GFDI_Ground_Failure	Reserved.
F05	EEPROM_Read_Failure	Reserved.
F06	EEPROM_Write_Failure	Reserved.
F07	DC/DC_Softstart_Fault	Reserved.
F08	GFDI_Relay_Failure	Reserved.
F09	IGBT_Failure	Reserved.
F10	AuxPowerBoard_Failure	Reserved.
F11	AC_MainContactor_Failure	Reserved.
F12	AC_SlaveContactor_Failure	Reserved.

Fault Code	Definitions	Solutions
F13	Grid_Mode_changed	Triggered when switching modes like grid, battery, parallel, and other modes. If settings are correct, inverter resumes automatically.
F14	DC_OverCurr_Fault	The battery current has exceeded the allowable limit. If this fault happens repeatedly or cannot be cleared by restarting the inverter, consider the following checks: 1. Verify the maximum discharge current setting. 2. If using lithium batteries, ensure that the maximum discharge current rating of the battery is not being exceeded. 3. Inspect the battery current sensor and its related circuits.
F15	SW_AC_OverCurr_Fault	When the inverter is running, this fault may occur due to an overload or severe grid distortion. If the fault persists after restarting, the possible causes include: 1. Damage to the IGBT or its driver on the inverter side; 2. Malfunction of the current sensor or its related circuits.
F16	GFCI_Failure	Reserved.
F17	Active_Battery_Hold	Reserved.
F18	Tz_Ac_OverCurr_Fault	AC hardware over-current. Same checks as F15.
F19	Tz_Integ_Fault	Reserved.
F20	Tz_Dc_OverCurr_Fault	DC hardware over-current: This fault occurs when the input current from the solar panel exceeds the safe limit and cannot be restored automatically. Possible causes include: 1. Failure of the PV current sensor or a malfunction in the hardware over-current protection detection circuit. 2. Damage to the BOOST inductor.
F21	Tz_GFDI_OC_Fault	Reserved.
F22	Tz_EmergStop_Fault	Emergency stop. If the inverter stays in this state, please contact the distributor.
F23	Tz_GFCI_OC_Fault	Reserved.
F24	DC_Insulation_Fault	1. Check if the PV cable is damaged or broken. 2. Ensure the inverter is correctly assembled.
F25	Reserved.	Reserved.
F26	BusUnbalance_Fault	Reserved.

Fault Code	Definitions	Solutions
F27	PV_or_Grid_WAKE_UP_Failed	Battery wake-up failure: 1. Failure in boosting during PV wake-up. 2. Damage to the MOSFETs or their drivers on both sides of the transformer.
F28	DCIOver_M1_Fault	Reserved.
F29	Parallel_Comm_Fault	1. Setting error: Ensure the desired function is set according to the instructions, and check the master/slave settings and address configuration. 2. Incorrect connection: Verify the communication line is properly connected. 3. Faulty communication module: Inspect the devices connected to the parallel port for any issues.
F30	AC_MainContactor_Fault	Check relays and their drivers.
F31	Soft_Start_Failed	Reserved.
F32	DCIOver_M2_Fault	Overcharging current fault: This software protection feature prevents excessive charging current from damaging the battery. It rarely occurs, but may be caused by: 1. Full power charging and fluctuations in PV and grid input. 2. A faulty battery current sensor.
F33	AC_OverCurr_Fault	The bypass load is too high. This could be due to a fault in the Bypass CT (built-in limiter sensor) or its detection circuit.
F34	AC_Overload_Fault	This fault occurs when: 1. The AC load is too high. 2. The power grid mode is selected incorrectly (e.g., choosing the European model for a split-phase 120V output). 3. One or more IGBTs in the AC inverter bridge are not functioning properly.
F35	AC_NoUtility_Fault	This fault occurs in Grid-connected mode when there is no battery or if the battery is malfunctioning.
F36	AC_GridPhaseSeque_Fault	Reserved.
F37	Wake_up_Over_Current	Check the power cable connection to the battery terminals. Some MOSFET components may be damaged.
F38	Parallel_system_Stop	Reserved.
F39	Tz_Resonance_OverCurr_Fault	1. Sudden connection of a heavy load 2. Damaged MOSFET. 3. Faulty resonant capacitor or transformer (rare). 4. Malfunction in the resonant current detection circuit (rare).

Fault Code	Definitions	Solutions
F40	Gen_OverCurr_Fault	Reserved.
F41	AC_WU_OverVolt_Fault	This error only occurs when the inverter is operating in no battery mode and grid-connected mode: 1. Verify the grid voltage is within the normal range. 2. Check the internal voltage sampling.
F42	AC_WU_UnderVolt_Fault	Same checks as F41.
F43	AC_VW_OverVolt_Fault	Reserved.
F44	AC_VW_UnderVolt_Fault	Reserved.
F45	AC_UV_OverVolt_Fault	Reserved.
F46	AC_UV_UnderVolt_Fault	Reserved.
F47	AC_OverFreq_Fault	This error only occurs when the inverter is operating in no battery mode and grid-connected mode: 1. Verify the grid frequency is within the normal range. 2. Check the internal frequency sampling.
F48	AC_UnderFreq_Fault	Same checks as F47.
F49	Backup_Battery_Fault	Reserved.
F50	AC_softstart_Fault	Wait for the system to attempt an automatic restart, or manually restart the inverter using the power switch. If the issue persists, please contact your distributor for assistance.
F51	Battery_TempHigh	Turn off battery and check temperature.
F52	AC_B_InductCurr_DcHigh_Fault	Reserved.
F53	AC_A_InductCurr_DcHigh_Fault	Reserved.
F54	AC_C_InductCurr_DcHigh_Fault	Reserved.
F55	DC_VoltHigh_Fault	1. Check the battery voltage. 2. Check the input voltage from the PV system. 3. Inspect the capacitor for any signs of abnormal damage.
F56	DC_VoltLow_Fault	1. Check the battery voltage. 2. Inspect the bus capacitor for any signs of abnormal damage.
F57	AC_BackFeed_Fault	Reserved.
F58	BMS_Communication_Fault	1. Check the connection between the battery BMS and the inverter. 2. Verify the lithium battery settings and inverter settings. 3. If replacing the battery does not resolve the issue, inspect the inverter's BMS communication circuit.

Fault Code	Definitions	Solutions
F59	AC_V_GridCurr_High_Fault	The AC voltage or current is too high. This fault only occurs when the inverter is operating in no-battery mode, and in most cases, it will recover automatically. If the inverter reports this fault frequently, the possible reasons may include: 1. A weak power grid with significant voltage distortion. 2. A fault in the voltage detection circuit.
F60	Gen_Volt_or_Fre_Fault	Reserved.
F61	Button_Manual_OFF	Reserved.
F62	DRMs_Stop	Reserved.
F63	Arc_Fault	Reserved.
F64	AC_V_GridCurr_High_Fault	Heat-wink high temperature: 1. The ambient temperature may be too high, or there may be poor ventilation around the device. 2. The temperature sensor may be malfunctioning.

9.3 Troubleshooting for Battery Module

Problem Description	Analysis Method	Measures
If the on-site low-voltage battery can not obtain fault information from the SOC indicator lights, prioritize upgrading to the latest version of the battery firmware to retrieve fault information for further analysis.		
SOC fluctuations in a single battery pack system	1. Check the SOC logs to determine whether SOC fluctuations occur after reaching 0% or 100% SOC as starting points, while the current is sustained. Verify if SOC fluctuations happen during both charging to 100% and discharging to 0%, or if they only occur during charging/ discharging processes.	1. If SOC fluctuations occur during both charging and discharging processes, it may indicate insufficient battery capacity. Determine if it is normal capacity degradation or abnormal capacity degradation based on the battery's usage duration. If abnormal degradation is identified, the customer should replace the battery.
The SOC records on the cloud platform frequently exhibit fluctuations from SOC values above 10% to 0% or from below 90% to 100%.	2. If there are no fluctuations from 100% to 0% or from 0% to 100%, and if fluctuations occur only after more than 2 days without reaching full charge or full discharge;	2. If the fluctuations occur only during discharging and primarily happen after the battery has been idle for an extended period, it indicates that the zero drift of the battery current sampling is too significant. Customers should upgrade to a battery firmware with reduced zero drift for sampling.

Problem Description	Analysis Method	Measures
<p>Mos sticking fault</p> <p>The battery displays a sticking indicator light.</p>	<p>1. Use a voltmeter to measure the voltage between P+ and P- to confirm if the voltage is around 51V, which is the battery voltage;</p>	<p>1. Upgrade to the latest battery firmware to clear the Mos sticking fault.</p> <p>If there is a 51V voltage present at the P+ and P- terminals, it is necessary to replace the BMS board.</p>
<p>SOC fluctuations in multi-battery pack systems</p> <p>SOC records on the cloud platform often fluctuate from one SOC value to another, and after a certain period of time, they will return to the original value</p>	<p>1. Verify on-site whether individual batteries frequently display a red fault indicator light;</p> <p>2. Retrieve battery historical events or fault codes for further analysis;</p>	<p>1. Replace the problematic battery pack or handle the specific issue according to the specific fault.</p>
<p>No communication between the battery and the inverter</p>	<p>1. Check if the Deye inverter operating mode is set to lithium battery mode.</p> <p>2. Check if the communication protocol setting for the Deye inverter is 00 (CAN communication mode).</p> <p>3. Verify if there are normal messages on the battery pack communication port (PCS CAN), such as 0x350, 0x351, at a baud rate of 500k.</p> <p>4. Check if the inverter communication port (CAN) is properly connected to the battery pack communication port (PCS CAN) using the correct connecting wire.</p> <p>5. Review the test records to see if there are any PASS records for the PCS CAN communication test.</p>	<p>1. Once the issue is identified as per the analysis method, proceed with the corresponding solution.</p>
<p>The battery SOC always stops at 99% and cannot reach 100%.</p>	<p>1. Check the power distribution of the inverter and verify if the charging current is allocated at the charging end according to the charging limit current reported by the battery</p>	<p>1. Modify the inverter settings;</p>
<p>Voltage/Temperature disconnection fault reported</p> <p>The battery goes into abnormal sleep mode after the red light comes on</p>	<p>1. Check if there are any loose pins in the data acquisition line connector.</p> <p>2. Verify if the data acquisition wiring harness is broken.</p> <p>3. Inspect the BMS board for any burnt circuit in the data acquisition circuits.</p>	<p>1. Replace the data acquisition line;</p> <p>2. Replace BMS;</p>
<p>MOS over-temperature fault reported</p>	<p>1. Check whether the screws of B- and P- power connectors are tightened and inspect for any loose soldering joints or disconnected pins on the terminal;</p> <p>2. Inspect for any loose soldering joints or disconnected pins on the Mos.</p>	<p>1. Tighten the screws;</p> <p>2. Replace BMS;</p>

Problem Description	Analysis Method	Measures
Cell high voltage protection	<ol style="list-style-type: none"> 1. Check if there are any abnormalities in the data acquisition wiring harness. 2. Measure cell voltages using a multi-meter. 3. Check the SOH of the battery pack 4. Check the historical records for instances of repeated charging with low current. 	<ol style="list-style-type: none"> 1. Replace the data acquisition line; 2. Replace BMS;
Cell low voltage protection	<ol style="list-style-type: none"> 1. Check if there are any abnormalities in the data acquisition wiring harness. 2. Measure cell voltages using a multi-meter. 3. Check the SOH of the battery pack 4. Check the historical records for instances of forced relay opening (cutting power) by the PCS. 	<ol style="list-style-type: none"> 1. Replace the data acquisition line; 2. Replace BMS; 3. Replace the battery pack.
Battery pack Overvoltage protection	<ol style="list-style-type: none"> 1. Check whether the charging and discharging MOS is functioning properly 2. Check the ambient temperature of the battery pack. 3. Check if the battery pack is too old or damaged. 	<ol style="list-style-type: none"> 1. Replace BMS; 2. Replace the battery pack.
Battery pack Undervoltage protection	<ol style="list-style-type: none"> 1. Check the power supply cables between battery packs 2. Check if the battery pack is too old or damaged. 	<ol style="list-style-type: none"> 1. Replace the wiring harness. 2. Replace the battery pack.
Overcurrent protection during charging	<ol style="list-style-type: none"> 1. Check if there is any damage, loose contact, or short circuiting in the charging port or wiring. 2. Check if the BMS board is functioning properly. 	<ol style="list-style-type: none"> 1. Replace the wiring harness. 2. Replace BMS
Overcurrent protection during discharging	<ol style="list-style-type: none"> 1. Check for sudden increases in load while the battery is in use. 2. Check the SOH of the battery. Damage, aging, or faults in internal battery components may lead to an increase in internal resistance. 3. Check if the temperature of the battery pack itself and the ambient temperature are normal. 4. Check if the BMS board is functioning properly. 	<ol style="list-style-type: none"> 1. Replace BMS; 2. Replace the battery pack.
High-temperature protection during charging	<ol style="list-style-type: none"> 1. Check for instances of rapid high-current charging. 2. Check for instances of prolonged charging. 3. Check the ambient temperature of the battery pack. 4. Check if the battery pack is too old or damaged. 	<ol style="list-style-type: none"> 1. Control or reduce the charging current. 2. Ensure that the battery pack is at a reasonable ambient temperature. 3. Replace the battery pack.

Problem Description	Analysis Method	Measures
Low-temperature protection during charging	1. Check the ambient temperature of the battery pack. 2. Check the heating current.	1. Ensure that the battery pack is at a reasonable ambient temperature.
High-temperature protection during discharging	1. Check for sudden increases in load while the battery is in use. 2. Check if the battery pack is over-discharged. 3. Check the ambient temperature of the battery pack.	1. Ensure the stability of the load connection. 2. Ensure that the battery pack is at a reasonable ambient temperature. 3. Replace the battery pack.
Low-temperature protection during discharging	1. Check for instances of rapid high-current discharging. 2. Check the ambient temperature of the battery pack. 3. Check the SOH of the battery pack	1. Ensure that the battery pack is at a reasonable ambient temperature. 2. Replace the battery pack.
Protection against excessively large cell voltage difference	1. Check if the voltage acquisition wiring harness is functioning properly. 2. Measure cell voltages using a multimeter. 3. Verify if the BMS board's balancing function is normal.	1. Replace the wiring harness. 2. Replace the battery pack.
Protection against excessive temperature difference	1. Check the ambient temperature of the battery pack. 2. Check the temperature acquisition wiring harness 3. Check if the battery cell is damaged.	1. Ensure that the battery pack is at a reasonable ambient temperature. 2. Replace the battery pack.
MOS high temperature protection	1. Check the ambient temperature of the battery pack. 2. Check the charging and discharging currents.	1. Replace BMS
OCD1	Level 1 overcurrent protection during discharging	
OCD2	Level 2 overcurrent protection during discharging	
AFE UV	AFE undervoltage fault	
AFE OV	AFE overvoltage fault	
OCDL	Discharging overcurrent latch	
OCC	Overcurrent protection during charging	
SCD	Short circuiting protection during discharging	
SCDL	Permanent failure of discharging short circuiting latch	
AFE communication failure	1. Check if there are any signs of burning on the AFE pins. 2. Check if there are any signs of burning on the BMS board. 3. Measure if the AFE communication pins have communication signal levels.	1. Restart the system 2. Replace BMS board

Problem Description	Analysis Method	Measures
MOSFET short circuiting	1. Check whether there is a transient overvoltage, overcurrent event, and electromagnetic interference 2. Check the temperature of the battery pack	1. Replace the BMS board
EEPROM fault	1. Check if there are any signs of burning on the BMS board. 2. Check if there is electromagnetic interference in the environment. 3. Open the LAN host computer, read all BMS parameters, and check if the reading is successful.	1. If unable to read, then replace the BMS board. 2. If able to read successfully, then restart.
Internal communication failure	1. Check whether the connection of the communication wiring harness is loose 2. Check whether the battery pack starts up and runs normally	1. Replace the wiring harness.
Host address duplication	1. Check if the DI DO connections are correct.	1. Adjust the connected wiring harness. 2. Restart the master first and then restart the slave
Abnormal heating	1. Check whether the heating MOS is stuck or if it has trouble switching 2. Check whether the heating time is too long	1. Replace BMS
Pre-charge failure	1. Check if the pre-charge MOS is stuck and having trouble closing/opening properly.	1. Replace BMS
Reverse connection for charging	1. Check the positive and negative connections .	1. Reconnect the wiring harness correctly
Fuse blown fault	1. Check whether the cell voltage is greater than 4.1V 2. Check for MOS short-circuiting fault and the following faults triggered at the same time: Voltage acquisition line disconnected Temperature acquisition line disconnected AFE communication fault Temperature acquisition fault Cell voltage acquisition fault AFE fault information Charging reverse connection fault Maximum cell voltage exceeding 3.8V Cell volt high level 2 Maximum cell temperature exceeding 65°C Minimum cell temperature reaching 0°C MOS temperature exceeding 100°C	1. Replace BMS

10. Appendix

10.1 After-sales Service

If you encounter a fault during use and cannot resolve it by following the instructions in the user manual, please contact your dealer promptly. Provide clear feedback to the after-sales service team, including the product model, purchase date, contact phone number, and description of the fault.

- ① This product has a limited warranty. For detailed terms, please refer to the warranty statement. To confirm the purchase date, it is advised to keep the purchase receipt or online shopping records.
- ② During the warranty period, if the product is damaged due to manufacturing defects or material issues (non-human causes), the company will provide free repair or parts replacement.
- ③ The warranty does not cover the following conditions:
 - Unauthorized disassembly or repair;
 - Product failures caused by human factors;
 - Damage due to force majeure, such as natural disasters, lightning, or accidents;
 - Appearance damage caused after usage.

10.2 Disposal Instructions

- ① Please follow all applicable regulations for waste battery disposal.
- ② Stop using the battery immediately if it is damaged.
- ③ Before disposal, contact your installer or sales partner for proper guidance.
- ④ Make sure the battery is not exposed to moisture or direct sunlight.



ATTENTION:

- * Do not throw batteries or rechargeable batteries into household waste! You are legally required to return used batteries and rechargeable batteries to designated collection points.
- * Waste batteries may contain harmful substances that can damage the environment or harm your health if not handled or stored properly.
- * Batteries also contain iron, lithium, and other valuable raw materials that can be recycled.



10.3 EU Declaration of Conformity



Within the scope of the EU Directives:

- Radio Equipment Directive 2014/53/EU (RED)
- Restriction of the use of certain hazardous substances 2011/65/EU (RoHS)

NINGBO DEYE INVERTER TECHNOLOGY CO., LTD. confirms herewith that the products described in this document are in compliance with the fundamental requirements and other relevant provisions of the above mentioned directives. The entire EU Declaration of Conformity and certificate can be found at <https://www.deyeinverter.com/download/#balcony-energy-storage>.

EU Declaration of Conformity

Product: **All-in-one Micro Energy Storage System**

Models: SUN-BK80-2.56KWH-AA-AM4-18L ;SUN-BK160-2.56KWH-AA-AM4-18L;SUN-BK200-2.56KWH-AA-AM4-18L;
SUN-BK250-2.56KWH-AA-AM4-18L;SUN-BK80-2.56KWH-AA-AM4-32L;SUN-BK160-2.56KWH-AA-AM4-32L;
SUN-BK200-2.56KWH-AA-AM4-32L;SUN-BK250-2.56KWH-AA-AM4-32L

Name and address of the manufacturer: Ningbo Deye Inverter Technology Co., Ltd.
No. 26 South YongJiang Road, Daqi, Beilun, NingBo, China

This declaration of conformity is issued under the sole responsibility of the manufacturer. Also this product is under manufacturer's warranty.

This declaration of conformity is not valid any longer: if the product is modified, supplemented or changed in any other way, as well as in case the product is used or installed improperly.

The object of the declaration described above is in conformity with the relevant Union harmonization legislation:

- Radio Equipment Directive (RED) 2014/53/EU.
- Restriction of the use of certain Hazardous Substances (RoHS) Directive 2011/65/EU and 2015/863/EU



References to the relevant harmonized standards used or references to the other technical specifications in relation to which conformity is declared:

Health and Safety (RED, Article 3.1a)	
EN IEC 62311:2020	●
EN 62109-1:2010	●
EN 62109-2:2011	●
EMC (RED, Article 3.1b)	
EN IEC 61000-6-1:2019	●
EN IEC 61000-6-2:2019	●
EN IEC 61000-6-3:2021	●
EN IEC 61000-6-4:2019	●
EN 301489-1 V2.2.3:2019	●
EN 301489-17 V 3.2.4:2020	●
EN 55011:2016+A1+A11+A2	●
EN 61000-3-3:2013+A1	●
EN 62920:2017+A11+A1	●
EN IEC 61000-3-2:2019	●
CISPR 11:2024	●
EN IEC 61000-3-11:2019	●

EN 61000-3-12:2011+A1	●
Radio Aspects (RED, Article 3.2)	
EN 300328 V2.2.2:2019	●
Cybersecurity (RED, Article 3.3)	
EN 18031-1:2024	●
RoHS	
EN IEC 63000:2018	●

Additional information: CE mark was affixed on the product since 2026.

Nom et Titre / Name and Title:

Bard Dai
Senior Standard and Certification Engineer
宁波德业变频技术有限公司

Au nom de / On behalf of:

Ningbo Deye Inverter Technology Co., Ltd.

Date / Date (yyyy-mm-dd):

2026-03-09

A / Place:

Ningbo, China

10.4 Technical Data

Model	SUN-BK80-2.56 KWH-AA-AM4-18L	SUN-BK160-2.56 KWH-AA-AM4-18L	SUN-BK200-2.56 KWH-AA-AM4-18L	SUN-BK250-2.56 KWH-AA-AM4-18L
Battery Input Data				
Battery Type	LiFePO ₄			
Battery Voltage Range(V)	44.8-57.6			
Max. Charging Current(A)	50			
Max. Discharging Current(A)	50			
Battery Nominal Energy (Wh)	2560			
Charging Strategy for Li-ion Battery	Self-adaption to BMS			
PV String Input Data				
Max. PV access power(W)	4400			
Max. PV Input Power (W)	3750			
Max. PV Input Voltage(V)	60			
Start-up Voltage(V)	25			
MPPT voltage range(V)	20-55			
Full Load MPPT Voltage Range(V)	25-55	25-55	33-55	40-55
Rated PV Input voltage(V)	42.5			
Max. Input Short-Circuit Current (A)	32+32+32+32			
Max. Operating PV Input Current(A)	18+18+18+18			
No. of MPP Trackers/ No. of Strings MPP Tracker	4/1+1+1+1			
Max. Inverter Backfeed Current To the Array	0			
AC Input/Output Data				
Rated AC Input/Output Active Power(W)	800	1600	2000	2500
Max. AC Input/Output Apparent Power (VA)	880	1760	2200	2750
Max. off grid power(W)	2500			
Peak Power (off-grid) (W)	2 times of rated power, 10s			
Rated AC Input/Output Current(A)	3.7/3.5	7.3/7.0	9.1/8.7	11.4/10.9
Max. AC Input/Output Current(A)	4/3.9	8/7.7	10/9.6	12.5/12
Max. Continuous AC Passthrough (grid to load)(A)	30			
Max. Output Fault Current(A)	40			
Max. Output Overcurrent Protection (A)	27			
Rated Input/Output Voltage/Range(V)	220V/230V 0.85Un-1.1Un			
Grid Connection Form	L+N+PE			
Rated Input/Output Grid Frequency/Range	50Hz/45Hz-55Hz 60Hz/55Hz-65Hz			
Power Factor Adjustment Range	0.8 leading-0.8lagging			
Total Current Harmonic Distortion THDi	<3%			
DC Injection Current	<0.5%In			

Model	SUN-BK80-2.56 KWH-AA-AM4-18L	SUN-BK160-2.56 KWH-AA-AM4-18L	SUN-BK200-2.56 KWH-AA-AM4-18L	SUN-BK250-2.56 KWH-AA-AM4-18L
Efficiency				
Max. Efficiency	96.5%			
Euro Efficiency	96%			
MPPT Efficiency	>99%			
Equipment Protection				
DC reverse polarity protection	YES			
AC Output Overcurrent Protection	YES			
AC Output Overvoltage Protection	YES			
AC Output Short Circuit Protection	YES			
Thermal Protection	YES			
Insulation Impedance detection	YES			
Anti-islanding protection	YES			
Surge Protection Level	TYPE II(DC),TYPE II(AC)			
Interface				
LCD/LED display	LCD+LED			
Communication Interface	WiFi, Bluetooth, Lora			
General Data				
Max. Operating Frequency(Hz)	2.412GHz-2.472GHz			
Permissible Ambient Humidity	0%-95%			
Permissible Altitude (m)	2000m			
Ingress Protection(IP) Rating	IP 65			
Inverter Topology	Isolated			
Over Voltage Category	OVC II(DC),OVC II(AC)			
Cabinet Size (W*H*D) [mm]	560*330*210			
Weight [kg]	30			
Warranty [year]	10 years			
Type Of Cooling	Intelligent air cooling			
Grid Regulation	VDE 4105,IEC 61727/62116,VDE 0126,AS 4777.2,CEI 0-21, EN 50549-1,G98,C10-11,UNE 217002,			
Safety EMC/Standard	IEC 62619,UN38.3,IEC/EN 62109-1, IEC/EN 62109-2 IEC/EN 61000-6-1/2/3/4,			

Model	SUN-BK80-2.56 KWH-AA-AM4-32L	SUN-BK160-2.56 KWH-AA-AM4-32L	SUN-BK200-2.56 KWH-AA-AM4-32L	SUN-BK250-2.56 KWH-AA-AM4-32L
Battery Input Data				
Battery Type	LiFePO ₄			
Battery Voltage Range(V)	44.8-57.6			
Max. Charging Current(A)	50			
Max. Discharging Current(A)	50			
Battery Nominal Energy (Wh)	2560			
Charging Strategy for Li-ion Battery	Self-adaption to BMS			
PV String Input Data				
Max. PV access power(W)	5760			
Max. PV Input Power (W)	5000			
Max. PV Input Voltage(V)	60			
Start-up Voltage(V)	25			
MPPT voltage range(V)	20-55			
Full Load MPPT Voltage Range(V)	25-55			
Rated PV Input voltage(V)	42.5			
Max. Input Short-Circuit Current (A)	48+48+48+48			
Max. Operating PV Input Current(A)	32+32+32+32			
No. of MPP Trackers/ No. of Strings MPP Tracker	4/1+1+1+1			
Max. Inverter Backfeed Current To the Array	0			
AC Input/Output Data				
Rated AC Input/Output Active Power(W)	800	1600	2000	2500
Max. AC Input/Output Apparent Power (VA)	880	1760	2200	2750
Max. off grid power(W)	2500			
Peak Power (off-grid) (W)	2 times of rated power,10s			
Rated AC Input/Output Current(A)	3.7/3.5	7.3/7.0	9.1/8.7	11.4/10.9
Max. AC Input/Output Current(A)	4/3.9	8/7.7	10/9.6	12.5/12
Max. Continuous AC Passthrough (grid to load)(A)	30			
Max. Output Fault Current(A)	40			
Max. Output Overcurrent Protection (A)	27			
Rated Input/Output Voltage/Range(V)	220V/230V 0.85Un-1.1Un			
Grid Connection Form	L+N+PE			
Rated Input/Output Grid Frequency/Range	50Hz/45Hz-55Hz 60Hz/55Hz-65Hz			
Power Factor Adjustment Range	0.8 leading-0.8lagging			
Total Current Harmonic Distortion THDi	<3%			
DC Injection Current	<0.5%In			

Model	SUN-BK80-2.56 KWH-AA-AM4-32L	SUN-BK160-2.56 KWH-AA-AM4-32L	SUN-BK200-2.56 KWH-AA-AM4-32L	SUN-BK250-2.56 KWH-AA-AM4-32L
Efficiency				
Max. Efficiency	96.5%			
Euro Efficiency	96%			
MPPT Efficiency	>99%			
Equipment Protection				
DC reverse polarity protection	YES			
AC Output Overcurrent Protection	YES			
AC Output Overvoltage Protection	YES			
AC Output Short Circuit Protection	YES			
Thermal Protection	YES			
Insulation Impedance detection	YES			
Anti-islanding protection	YES			
Surge Protection Level	TYPE II(DC),TYPE II(AC)			
Interface				
LCD/LED display	LCD+LED			
Communication Interface	WiFi, Bluetooth, Lora			
General Data				
Permissible Ambient Humidity	0%-95%			
Permissible Altitude (m)	2000m			
Ingress Protection(IP) Rating	IP 65			
Inverter Topology	Isolated			
Over Voltage Category	OVC II(DC),OVC II(AC)			
Cabinet Size (W*H*D) [mm]	560*330*210			
Weight [kg]	30			
Warranty [year]	10 years			
Type Of Cooling	Intelligent air cooling			
Grid Regulation	VDE 4105,IEC 61727/62116,VDE 0126,AS 4777.2,CEI 0-21, EN 50549-1,G98,C10-11,UNE 217002,			
Safety EMC/Standard	IEC 62619,UN38.3,IEC/EN 62109-1, IEC/EN 62109-2 IEC/EN 61000-6-1/2/3/4,			

